

VIPA System SLIO

CPU | 013-CCF0R00 | Manual

HB300 | CPU | 013-CCF0R00 | GB | 16-16

SPEED7 CPU 013C

VIPA GmbH
Ohmstr. 4
91074 Herzogenaurach
Telephone: 09132-744-0
Fax: 09132-744-1864
Email: info@vipa.com
Internet: www.vipa.com

Table of contents

1	General	7
	1.1 Copyright © VIPA GmbH	7
	1.2 About this manual.....	8
	1.3 Safety information.....	9
2	Basics and mounting	11
	2.1 Safety information for users.....	11
	2.2 System conception.....	12
	2.2.1 Overview.....	12
	2.2.2 Components.....	12
	2.2.3 Accessories.....	15
	2.3 Dimensions.....	16
	2.4 Mounting.....	18
	2.4.1 Mounting CPU 01xC.....	18
	2.5 Wiring.....	20
	2.5.1 Wiring CPU 01xC.....	20
	2.5.2 Wiring periphery modules.....	23
	2.5.3 Wiring power modules.....	25
	2.6 Demounting.....	29
	2.6.1 Demounting CPU 01xC.....	29
	2.6.2 Demounting periphery modules.....	30
	2.7 Trouble shooting - LEDs.....	32
	2.8 Installation guidelines.....	33
	2.9 General data.....	36
3	Hardware description	38
	3.1 Properties.....	38
	3.2 Structure.....	39
	3.2.1 Compact CPU.....	39
	3.2.2 Interfaces.....	39
	3.2.3 Memory management.....	43
	3.2.4 Slot for storage media.....	43
	3.2.5 Buffering mechanisms.....	43
	3.2.6 Operating mode switch.....	44
	3.2.7 LEDs.....	44
	3.3 Technical data.....	48
4	Deployment CPU 013-CCF0R00	59
	4.1 Assembly.....	59
	4.2 Start-up behavior.....	59
	4.3 Addressing.....	59
	4.3.1 Overview.....	59
	4.3.2 Default address assignment of the I/O part.....	59
	4.3.3 Addressing periphery modules.....	60
	4.4 Hardware configuration - CPU.....	61
	4.5 Hardware configuration - System SLIO module.....	63
	4.6 Hardware configuration - Ethernet PG/OP channel.....	64
	4.7 Hardware configuration - communication.....	65
	4.8 Setting standard CPU parameters.....	66
	4.8.1 Parametrization via Siemens CPU.....	66

4.8.2	Parameter CPU.....	66
4.8.3	Parameter for MPI/DP	70
4.9	Setting VIPA specific CPU parameters.....	70
4.10	Project transfer.....	72
4.10.1	Transfer via MPI.....	72
4.10.2	Transfer via Ethernet.....	73
4.10.3	Transfer via memory card.....	74
4.11	Accessing the web server.....	75
4.11.1	Access via the Ethernet PG/OP channel.....	75
4.11.2	Structure of the web page.....	75
4.11.3	Web page with selected CPU.....	75
4.11.4	Web page with selected module.....	78
4.12	Operating modes.....	79
4.12.1	Overview.....	79
4.12.2	Function security.....	80
4.13	Overall reset.....	81
4.13.1	Overall reset by means of the operating mode switch	81
4.13.2	Overall reset by means of the Siemens SIMATIC Manager	82
4.13.3	Actions after a memory reset.....	82
4.14	Firmware update.....	82
4.15	Reset to factory settings.....	84
4.16	Deployment storage media - VSD, VSC.....	85
4.17	Extended know-how protection.....	87
4.18	CMD - auto commands.....	89
4.19	Control and monitoring of variables with test functions..	91
4.20	Diagnostic entries.....	92
5	Deployment I/O periphery.....	127
5.1	Overview.....	127
5.2	Address assignment.....	128
5.3	Analog input.....	128
5.3.1	Properties.....	128
5.3.2	Analog value representation.....	129
5.3.3	Wiring.....	130
5.3.4	Parametrization.....	131
5.4	Digital input.....	132
5.4.1	Properties.....	132
5.4.2	Wiring.....	133
5.4.3	Parametrization.....	134
5.4.4	Status indication.....	135
5.5	Digital output.....	135
5.5.1	Properties.....	135
5.5.2	Wiring.....	136
5.5.3	Parametrization.....	137
5.5.4	Status indication.....	137
5.6	Counting.....	138
5.6.1	Properties.....	138
5.6.2	Wiring.....	139
5.6.3	Proceeding.....	142
5.6.4	SFB 47 - COUNT - Counter controlling.....	142

5.6.5	Parametrization.....	148
5.6.6	Counter operating modes.....	153
5.6.7	Counter - Additional functions.....	160
5.6.8	Diagnostics and interrupt.....	167
5.7	Frequency measurement.....	167
5.7.1	Properties.....	167
5.7.2	Wiring.....	168
5.7.3	Proceeding.....	170
5.7.4	SFB 48 - FREQUENC - Frequency measurement.....	170
5.7.5	Parametrization.....	173
5.7.6	Status indication.....	175
5.8	Pulse width modulation - PWM.....	176
5.8.1	Properties.....	176
5.8.2	Wiring.....	177
5.8.3	Proceeding.....	178
5.8.4	SFB 49 - PULSE - Pulse width modulation.....	178
5.8.5	Parametrization.....	181
5.8.6	Status indication.....	184
5.9	Diagnostic and interrupt.....	184
5.9.1	Overview.....	184
5.9.2	Process interrupt.....	185
5.9.3	Diagnostic interrupt.....	187
6	Deployment PtP communication.....	198
6.1	Fast introduction.....	198
6.2	Principle of the data transfer.....	199
6.3	Enable PtP functionality.....	200
6.4	Deployment of RS485 interface for PtP.....	200
6.5	Parametrization.....	201
6.5.1	FC/SFC 216 - SER_CFG.....	201
6.6	Communication.....	205
6.6.1	Overview.....	205
6.6.2	FC/SFC 217 - SER_SND.....	205
6.6.3	FC/SFC 218 - SER_RCV.....	210
6.7	Protocols and procedures.....	212
6.8	Modbus - Function codes	216
7	Option: PROFIBUS communication.....	222
7.1	Overview.....	222
7.2	Fast introduction.....	223
7.3	Enable bus functionality via VSC.....	223
7.4	Deployment as PROFIBUS DP slave.....	224
7.5	PROFIBUS installation guidelines.....	226
7.6	Commissioning and Start-up behavior.....	229
8	Configuration with TIA Portal.....	231
8.1	TIA Portal - Work environment	231
8.1.1	General.....	231
8.1.2	Work environment of the TIA Portal.....	231
8.2	TIA Portal - Hardware configuration - CPU.....	232
8.3	TIA Portal - Hardware configuration - Ethernet PG/OP channel.....	235

8.4 TIA Portal - Include VIPA library.....	238
8.5 TIA Portal - Project transfer.....	239

1 General

1.1 Copyright © VIPA GmbH

All Rights Reserved

This document contains proprietary information of VIPA and is not to be disclosed or used except in accordance with applicable agreements.

This material is protected by the copyright laws. It may not be reproduced, distributed, or altered in any fashion by any entity (either internal or external to VIPA), except in accordance with applicable agreements, contracts or licensing, without the express written consent of VIPA and the business management owner of the material.

For permission to reproduce or distribute, please contact: VIPA, Gesellschaft für Visualisierung und Prozessautomatisierung mbH Ohmstraße 4, D-91074 Herzogenaurach, Germany

Tel.: +49 9132 744 -0

Fax.: +49 9132 744-1864

E-Mail: info@vipa.de

<http://www.vipa.com>



Every effort has been made to ensure that the information contained in this document was complete and accurate at the time of publishing. Nevertheless, the authors retain the right to modify the information.

This customer document describes all the hardware units and functions known at the present time. Descriptions may be included for units which are not present at the customer site. The exact scope of delivery is described in the respective purchase contract.

CE Conformity Declaration

Hereby, VIPA GmbH declares that the products and systems are in compliance with the essential requirements and other relevant provisions. Conformity is indicated by the CE marking affixed to the product.

Conformity Information

For more information regarding CE marking and Declaration of Conformity (DoC), please contact your local VIPA customer service organization.

Trademarks

VIPA, SLIO, System 100V, System 200V, System 300V, System 300S, System 400V, System 500S and Commander Compact are registered trademarks of VIPA Gesellschaft für Visualisierung und Prozessautomatisierung mbH.

SPEED7 is a registered trademark of profichip GmbH.

SIMATIC, STEP, SINEC, TIA Portal, S7-300 and S7-400 are registered trademarks of Siemens AG.

Microsoft and Windows are registered trademarks of Microsoft Inc., USA.

Portable Document Format (PDF) and Postscript are registered trademarks of Adobe Systems, Inc.

All other trademarks, logos and service or product marks specified herein are owned by their respective companies.

Information product support

Contact your local VIPA Customer Service Organization representative if you wish to report errors or questions regarding the contents of this document. If you are unable to locate a customer service centre, contact VIPA as follows:

VIPA GmbH, Ohmstraße 4, 91074 Herzogenaurach, Germany

Telefax: +49 9132 744-1204

E-Mail: documentation@vipa.de

Technical support

Contact your local VIPA Customer Service Organization representative if you encounter problems with the product or have questions regarding the product. If you are unable to locate a customer service centre, contact VIPA as follows:

VIPA GmbH, Ohmstraße 4, 91074 Herzogenaurach, Germany

Tel.: +49 9132 744-1150 (Hotline)

E-Mail: support@vipa.de

1.2 About this manual**Objective and contents**

This manual describes the CPU 013-CCF0R00 of the System SLIO from VIPA. It contains a description of the construction, project implementation and usage.

Product	Order number	as of state:	
		CPU-HW	CPU-FW
CPU 013C	013-CCF0R00	01	V1.4.2

Target audience

The manual is targeted at users who have a background in automation technology.

Structure of the manual

The manual consists of chapters. Every chapter provides a self-contained description of a specific topic.

- Guide to the document** The following guides are available in the manual:
- An overall table of contents at the beginning of the manual
 - References with page numbers
- Availability** The manual is available in:
- printed form, on paper
 - in electronic form as PDF-file (Adobe Acrobat Reader)
- Icons Headings** Important passages in the text are highlighted by following icons and headings:

**DANGER!**

Immediate or likely danger. Personal injury is possible.

**CAUTION!**

Damages to property is likely if these warnings are not heeded.



Supplementary information and useful tips.

1.3 Safety information

Applications conforming with specifications

The system is constructed and produced for:

- communication and process control
- industrial applications
- operation within the environmental conditions specified in the technical data
- installation into a cubicle

**DANGER!**

This device is not certified for applications in
– in explosive environments (EX-zone)

Documentation

The manual must be available to all personnel in the

- project design department
- installation department
- commissioning
- operation

**CAUTION!**

The following conditions must be met before using or commissioning the components described in this manual:

- Hardware modifications to the process control system should only be carried out when the system has been disconnected from power!
- Installation and hardware modifications only by properly trained personnel.
- The national rules and regulations of the respective country must be satisfied (installation, safety, EMC ...)

Disposal

National rules and regulations apply to the disposal of the unit!

2 Basics and mounting

2.1 Safety information for users

Handling of electrostatic sensitive modules

VIPA modules make use of highly integrated components in MOS-Technology. These components are extremely sensitive to over-voltages that can occur during electrostatic discharges. The following symbol is attached to modules that can be destroyed by electrostatic discharges.



The Symbol is located on the module, the module rack or on packing material and it indicates the presence of electrostatic sensitive equipment. It is possible that electrostatic sensitive equipment is destroyed by energies and voltages that are far less than the human threshold of perception. These voltages can occur where persons do not discharge themselves before handling electrostatic sensitive modules and they can damage components thereby, causing the module to become inoperable or unusable. Modules that have been damaged by electrostatic discharges can fail after a temperature change, mechanical shock or changes in the electrical load. Only the consequent implementation of protection devices and meticulous attention to the applicable rules and regulations for handling the respective equipment can prevent failures of electrostatic sensitive modules.

Shipping of modules

Modules must be shipped in the original packing material.

Measurements and alterations on electrostatic sensitive modules

When you are conducting measurements on electrostatic sensitive modules you should take the following precautions:

- Floating instruments must be discharged before use.
- Instruments must be grounded.

Modifying electrostatic sensitive modules you should only use soldering irons with grounded tips.



CAUTION!

Personnel and instruments should be grounded when working on electrostatic sensitive modules.

2.2 System conception

2.2.1 Overview

System SLIO is a modular automation system for assembly on a 35mm mounting rail. By means of the peripheral modules with 2, 4 or 8 channels this system may properly be adapted matching to your automation tasks. The wiring complexity is low, because the supply of the DC 24V power section is integrated to the backplane bus and defective modules may be replaced with standing wiring. By deployment of the power modules in contrasting colors within the system, further isolated areas may be defined for the DC 24V power supply, respectively the electronic power supply may be extended with 2A.

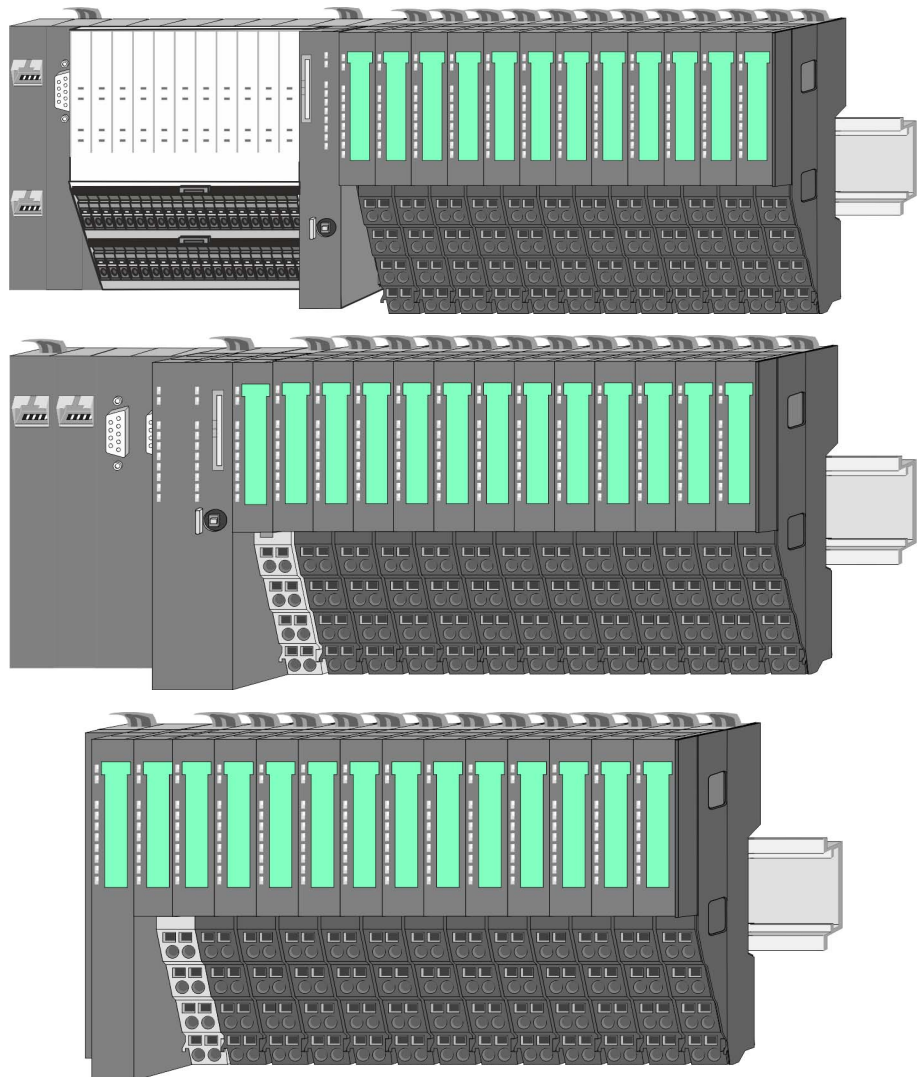

2.2.2 Components

- CPU (head module)
- Bus coupler (head module)
- Line extension
- Periphery modules
- Accessories



CAUTION!

Only modules of VIPA may be combined. A mixed operation with third-party modules is not allowed!

CPU 01xC

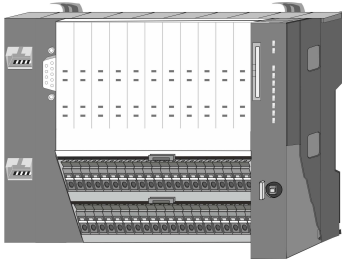

With this CPU 01xC, the CPU electronic, input/output components and power supply are integrated to one casing. In addition, up to 64 periphery modules of the System SLIO can be connected to the backplane bus. As head module via the integrated power supply CPU electronic and the I/O components are power supplied as well as the electronic of the connected periphery modules. To connect the power supply of the I/O components and for DC 24V power supply of via backplane bus connected peripheral modules, the CPU has removable connectors. By installing of up to 64 periphery modules at the backplane bus, these are electrically connected, this means these are assigned to the backplane bus, the electronic modules are power supplied and each periphery module is connected to the DC 24V power section supply.

CPU 01x



With this CPU 01x, the CPU electronic and power supply are integrated to one casing. As head module, via the integrated power module for power supply, CPU electronic and the electronic of the connected periphery modules are supplied. The DC 24 power section supply for the linked periphery modules is established via a further connection of the power module. By installing of up to 64 periphery modules at the backplane bus, these are electrically connected, this means these are assigned to the backplane bus, the electronic modules are power supplied and each periphery module is connected to the DC 24V power section supply.



CAUTION!

CPU part and power module may not be separated!
Here you may only exchange the electronic module!

Bus coupler

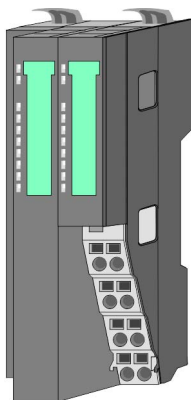

With a bus coupler bus interface and power module is integrated to one casing. With the bus interface you get access to a subordinated bus system. As head module, via the integrated power module for power supply, bus interface and the electronic of the connected periphery modules are supplied. The DC 24 power section supply for the linked periphery modules is established via a further connection of the power module. By installing of up to 64 periphery modules at the bus coupler, these are electrically connected, this means these are assigned to the backplane bus, the electronic modules are power supplied and each periphery module is connected to the DC 24V power section supply.

 **CAUTION!**
 Bus interface and power module may not be separated!
 Here you may only exchange the electronic module!

Line extension

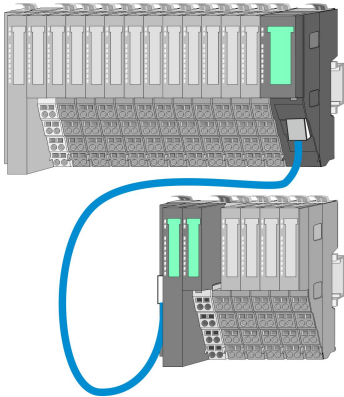

In the System SLIO there is the possibility to place up to 64 modules in on line. By means of the line extension you can divide this line into several lines. Here you have to place a line extension master at each end of a line and the subsequent line has to start with a line extension slave. Master and slave are to be connected via a special connecting cable. In this way, you can divide a line on up to 5 lines. To use the line extension no special configuration is required.

Periphery modules

Each periphery module consists of a *terminal* and an *electronic module*.

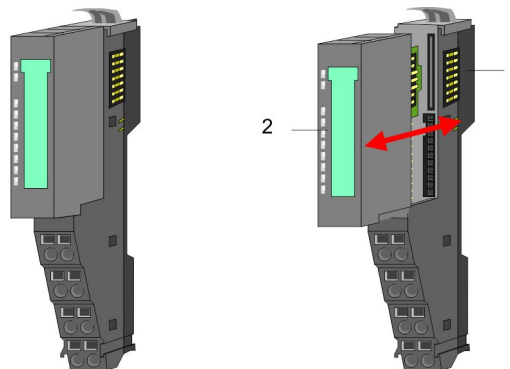

- 1 Terminal module
- 2 Electronic module

Terminal module

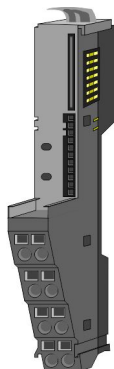

The *terminal* module serves to carry the electronic module, contains the backplane bus with power supply for the electronic, the DC 24V power section supply and the staircase-shaped terminal for wiring. Additionally the terminal module has a locking system for fixing at a mounting rail. By means of this locking system your SLIO system may be assembled outside of your switchgear cabinet to be later mounted there as whole system.

Electronic module

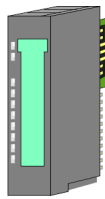

The functionality of a SLIO peripheral module is defined by the *electronic* module, which is mounted to the terminal module by a sliding mechanism. With an error the defective module may be exchanged for a functional module with standing installation. At the front side there are LEDs for status indication. For simple wiring each module shows a corresponding connection diagram at the front and at the side.

2.2.3 Accessories

Shield bus carrier

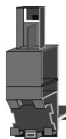

The shield bus carrier (order no.: 000-0AB00) serves to carry the shield bus (10mm x 3mm) to connect cable shields. Shield bus carriers, shield bus and shield fixings are not in the scope of delivery. They are only available as accessories. The shield bus carrier is mounted underneath the terminal of the terminal module. With a flat mounting rail for adaptation to a flat mounting rail you may remove the spacer of the shield bus carrier.

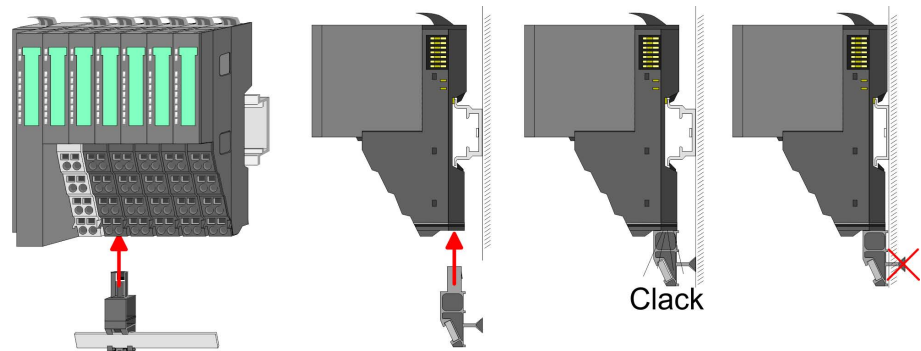

Bus cover

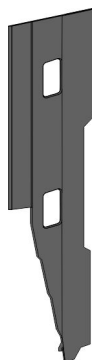

With each head module, to protect the backplane bus connectors, there is a mounted bus cover in the scope of delivery. You have to remove the bus cover of the head module before mounting a System SLIO module. For the protection of the backplane bus connector you always have to mount the bus cover at the last module of your system again. The bus cover has the order no. 000-0AA00.

Coding pins



There is the possibility to fix the assignment of electronic and terminal module. Here coding pins (order number 000-0AC00) from VIPA can be used. The coding pin consists of a coding jack and a coding plug. By combining electronic and terminal module with coding pin, the coding jack remains in the electronic module and the coding plug in the terminal module. This ensures that after replacing the electronics module just another electronic module can be plugged with the same encoding.

2.3 Dimensions

Dimensions CPU 01xC

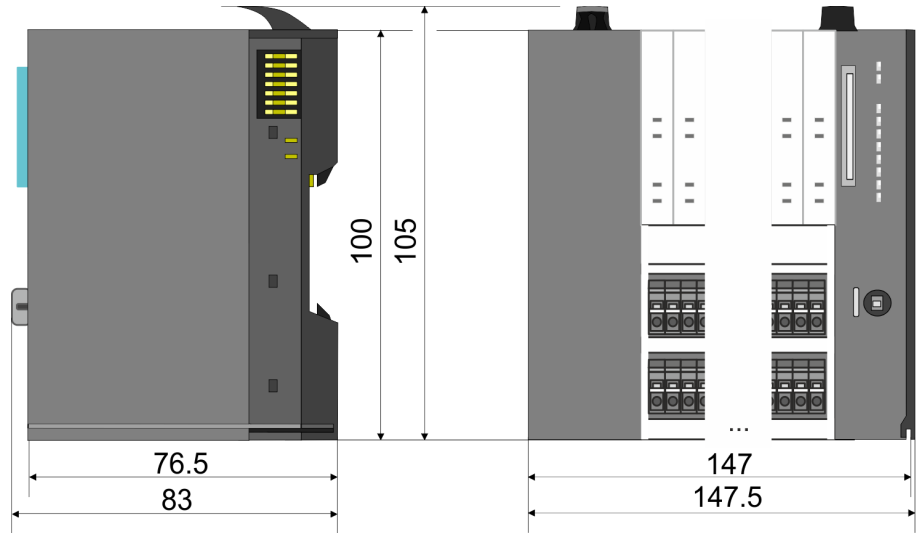

Dimensions CPU 01x

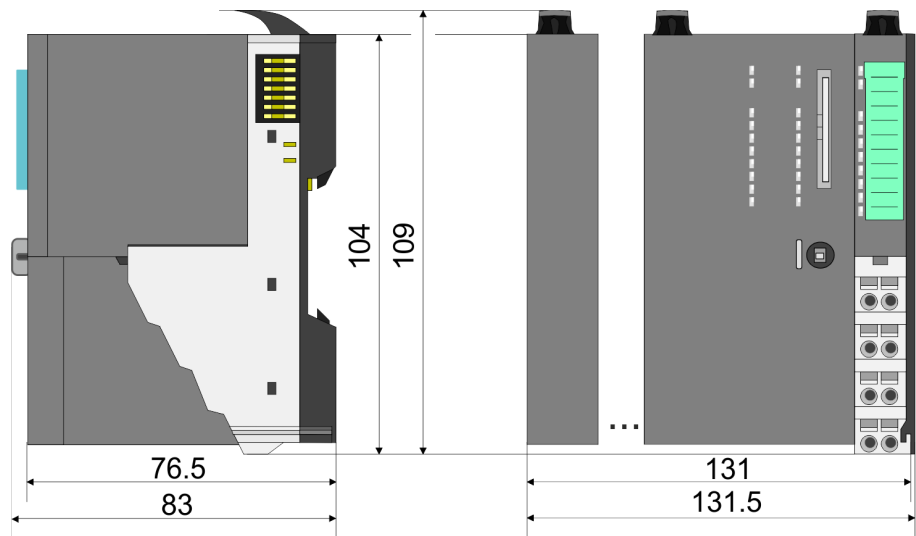

Dimensions bus coupler and line extension slave

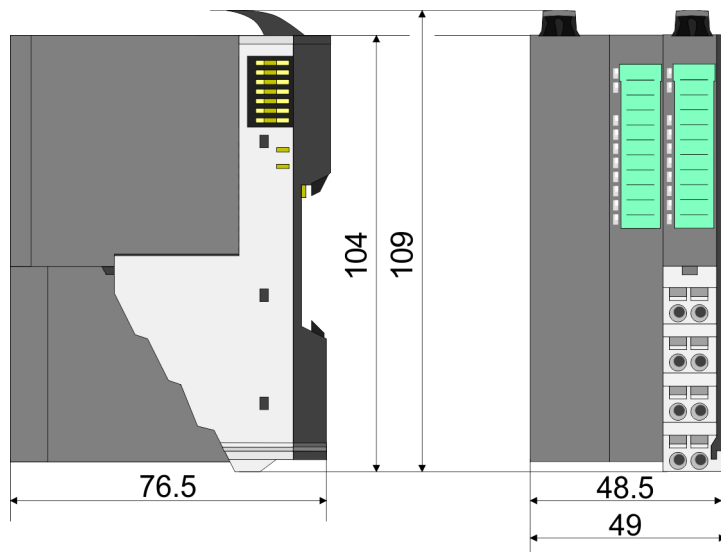

Dimensions line extension master

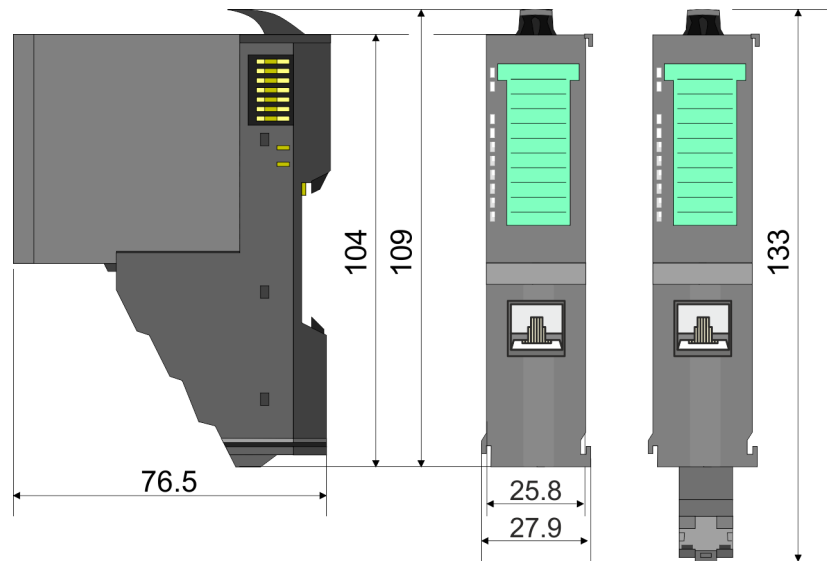

Dimension periphery module

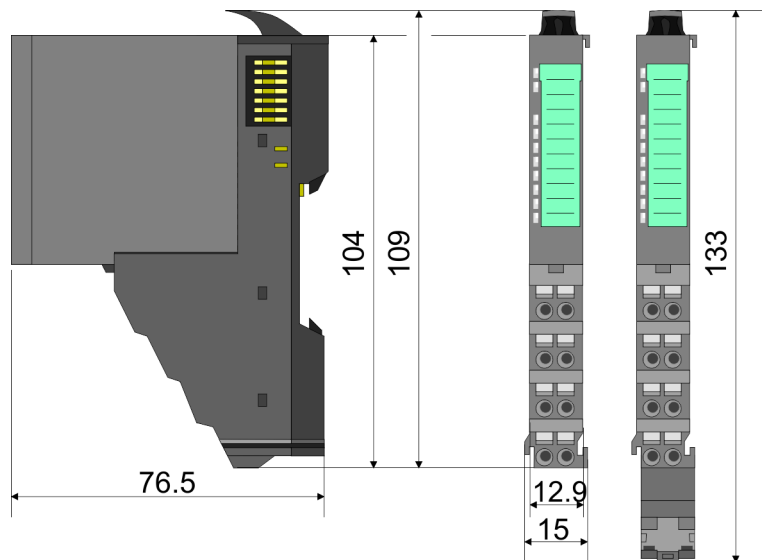

Dimensions electronic module

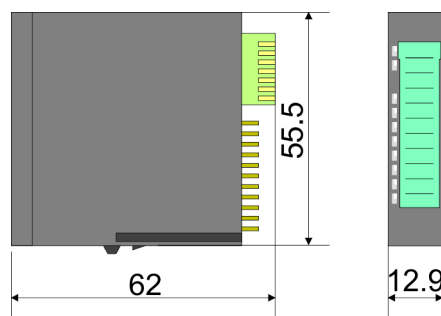

Dimensions in mm

2.4 Mounting

2.4.1 Mounting CPU 01xC

There are locking lever at the top side of the CPU. For mounting and demounting these locking lever are to be turned upwards until these engage. Place the CPU at the mounting rail. The CPU is fixed to the mounting rail by pushing downward the locking levers. The CPU is directly mounted at a mounting rail. Up to 64 modules may be mounted. The electronic and power section supply are connected via the backplane bus. Please consider here that the sum current of the electronic power supply does not exceed the maximum value of 1A. By means of the power module 007-1AB10 the current of the electronic power supply may be expanded accordingly.

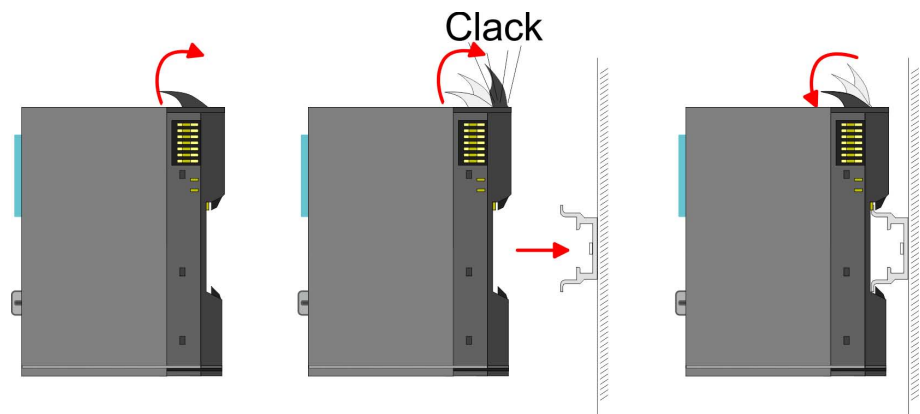

Proceeding

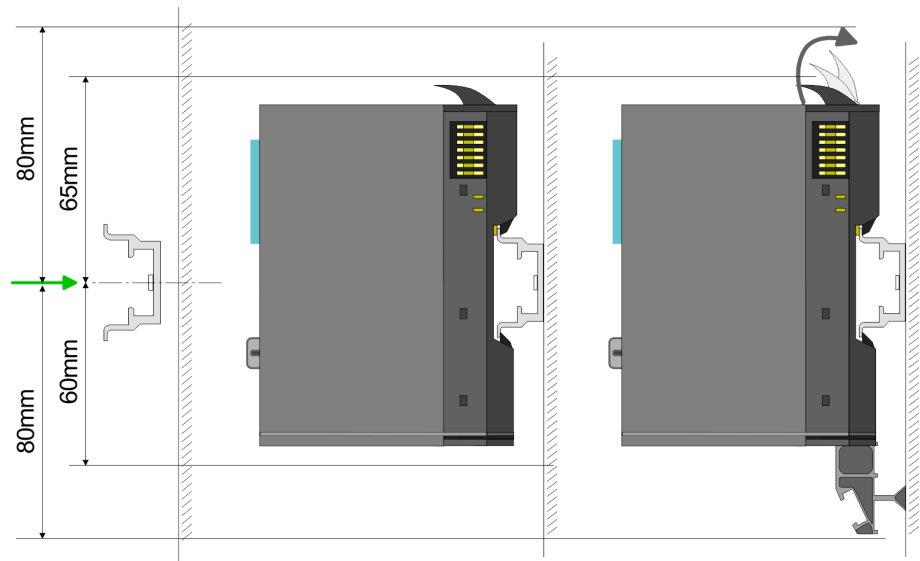

1. ➤ Mount the mounting rail! Please consider that a clearance from the middle of the mounting rail of at least 80mm above and 60mm below, respectively 80mm by deployment of shield bus carriers, exist.

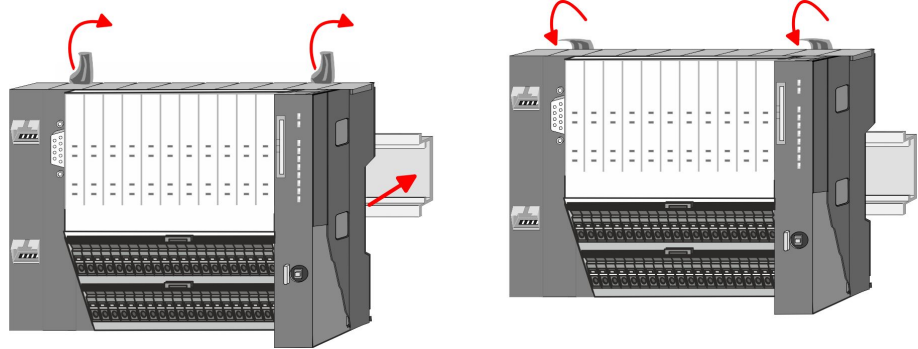

2. Turn the locking lever upwards, place the CPU at the mounting rail and turn the lever downward.
 - ⇒ If you want to use the CPU without periphery modules, the mounting is now complete.

Mounting periphery modules

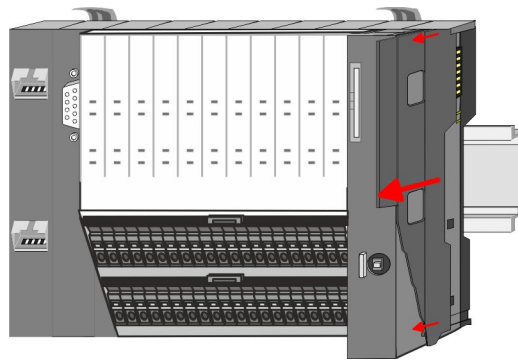

1. Before mounting the periphery modules you have to remove the bus cover at the right side of the CPU by pulling it forward. Keep the cover for later mounting.

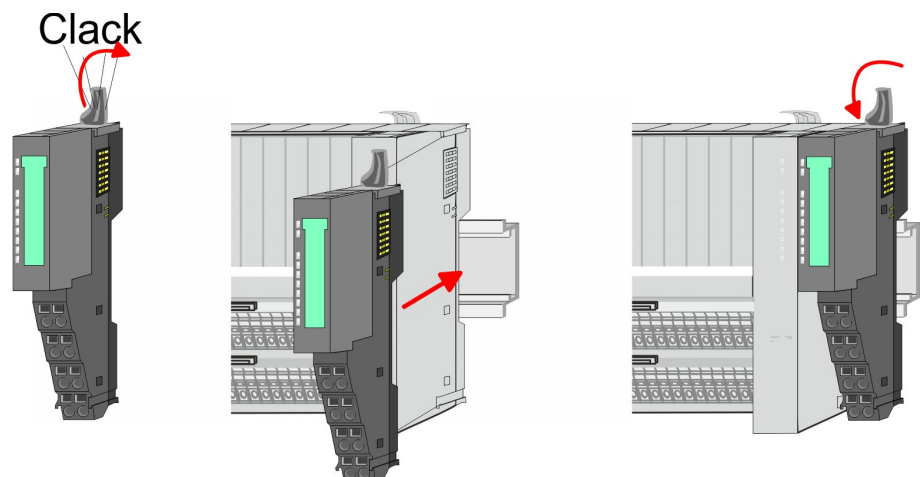

2. Mount the periphery modules you want.

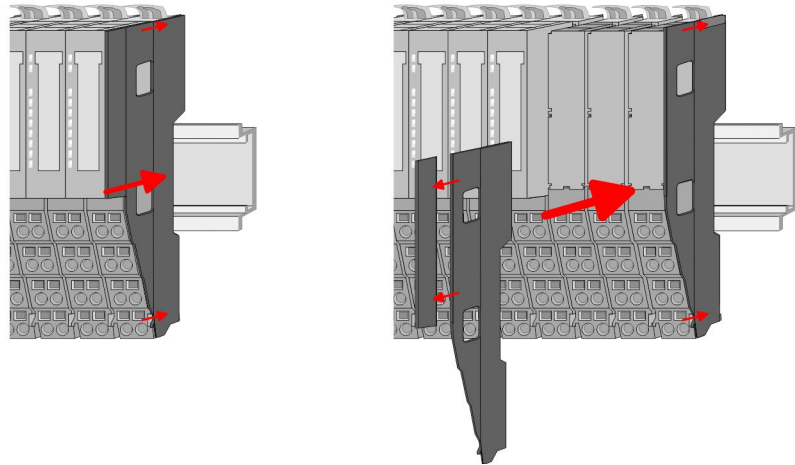

3. After mounting the whole system, to protect the backplane bus connectors at the last module you have to mount the bus cover, now. If the last module is a clamp module, for adaptation the upper part of the bus cover is to be removed.

2.5 Wiring

2.5.1 Wiring CPU 01xC

CPU connector

For wiring the CPU 01xC has removable connectors. With the wiring of the connectors a "push-in" spring-clip technique is used. This allows a quick and easy connection of your signal and supply lines. The clamping off takes place by means of a screwdriver.

Data

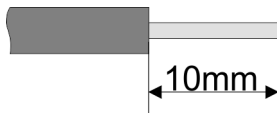

U_{max}	240V AC / 30V DC
I_{max}	10A
Cross section	0.08 ... 1.5mm ² (AWG 28 ... 16)
Stripping length	10mm

Use for wiring rigid wires respectively use wire sleeves. When using stranded wires you have to press the release button with a screwdriver during the wiring.

Wiring procedure

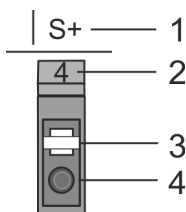

- 1 Labeling on the casing
- 2 Pin no. at the connector
- 3 Release button
- 4 Connection hole for wire

Insert wire

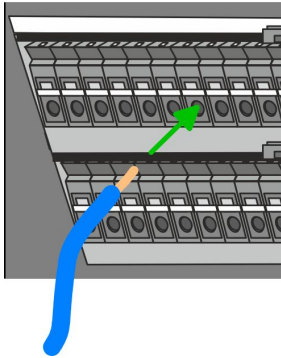

The wiring happens without a tool.

- ➔ Determine according to the casing labelling the connection position and insert through the round connection hole of the according contact your prepared wire until it stops, so that it is fixed.
- ⇒ By pushing the contact spring opens, thus ensuring the necessary contact pressure.

Remove wire

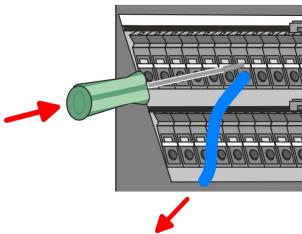

The wire is to be removed by means of a screwdriver with 2.5mm blade width.

1. ➔ Press with your screwdriver vertically at the release button.
 - ⇒ The contact spring releases the wire.
2. ➔ Pull the wire from the round hole.

Remove connectors (module replacement)

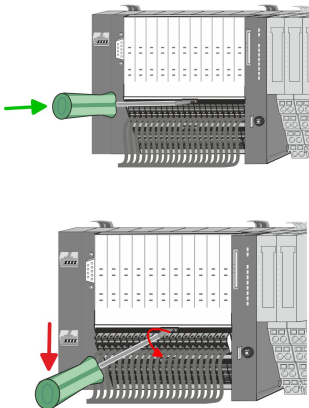

By means of a screwdriver there is the possibility to remove the connectors e.g. for module exchange with a fix wiring. For this each connector has a release lever centrally on its top side. Unlocking takes place by the following proceeding:

1. ➔ Remove connector:
Push your screwdriver horizontally into the slot between connector and release lever, until it stops.
2. ➔ Push the screwdriver down:
⇒ The connector is unlocked and can be removed by turning downwards.



CAUTION!

Via wrong operation such as pressing, the screwdriver upward the release lever may be damaged.

3. ➔ Plug connector:
The connector is plugged by setting it at the bottom line and engage with a with a slight twist upwards into the release lever.

Standard wiring

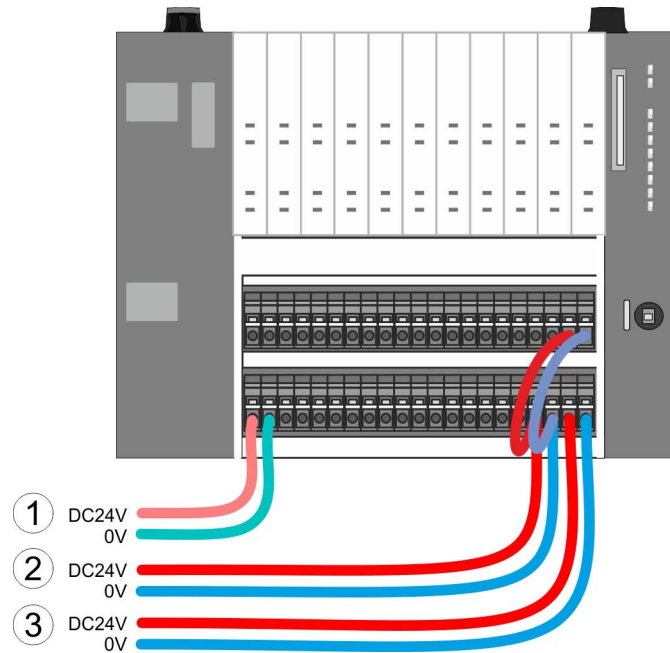

- (1) DC 24V for electronic section supply of the CPU, the internal I/Os and SLIO bus
- (2) DC 24V for power section supply integrated I/Os
- (3) DC 24V for power section supply SLIO bus



The electronic power section supply is internally protected against higher voltage by fuse. The fuse is located inside the CPU and can not be changed by the user.

Fusing

- It is recommended to externally protect the electronic power supply for CPU and SLIO bus with a 3A fuse (fast) respectively by a line circuit breaker 3A characteristics Z.
- The power section supply of the internal I/Os is to be externally protected with a 6A fuse (fast) respectively by a line circuit breaker 6A characteristics Z!
- The power section supply of the SLIO bus is to be externally protected with a 6A fuse (fast) respectively by a line circuit breaker 6A characteristics Z!

State of the electronic power supply via LEDs

After PowerON of the System SLIO the LEDs RUN respectively MF get on so far as the sum current does not exceed 1A. With a sum current greater than 1A the LEDs may not be activated. Here the power module with the order number 007-1AB10 is to be placed between the peripheral modules.

Shield attachment

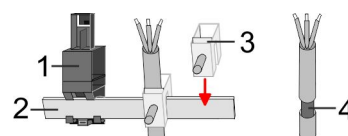

- 1 Shield bus carrier
- 2 Shield bus (10mm x 3mm)
- 3 Shield clamp
- 4 Cable shield

To attach the shield the mounting of shield bus carriers are necessary. The shield bus carrier (available as accessory) serves to carry the shield bus to connect cable shields.

1. ▶ Each System SLIO module has a carrier hole for the shield bus carrier. Push the shield bus carrier, until they engage into the module. With a flat mounting rail for adaptation to a flat mounting rail you may remove the spacer of the shield bus carrier.
2. ▶ Put your shield bus into the shield bus carrier.

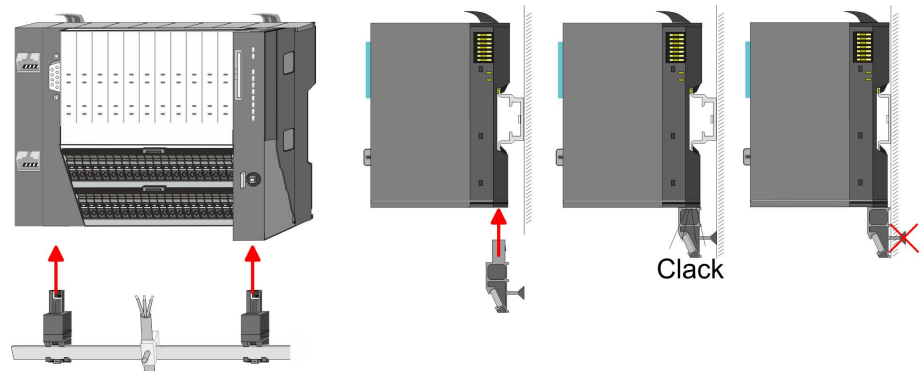

3. ▶ Attach the cables with the accordingly stripped cable screen and fix it by the shield clamp with the shield bus.

2.5.2 Wiring periphery modules

Terminal module terminals

With wiring the terminal modules, terminals with spring clamp technology are used for wiring. The spring clamp technology allows quick and easy connection of your signal and supply lines. In contrast to screw terminal connections this type of connection is vibration proof.

Data

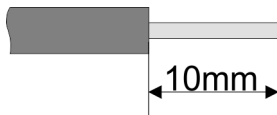

U_{max}	240V AC / 30V DC
I_{max}	10A
Cross section	0.08 ... 1.5mm ² (AWG 28 ... 16)
Stripping length	10mm

Wiring procedure

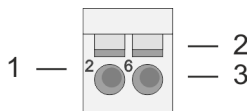

- 1 Pin number at the connector
- 2 Opening for screwdriver
- 3 Connection hole for wire

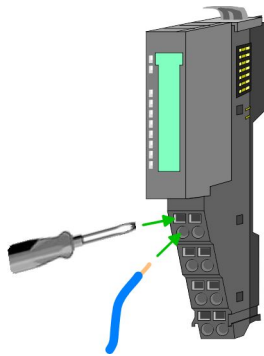
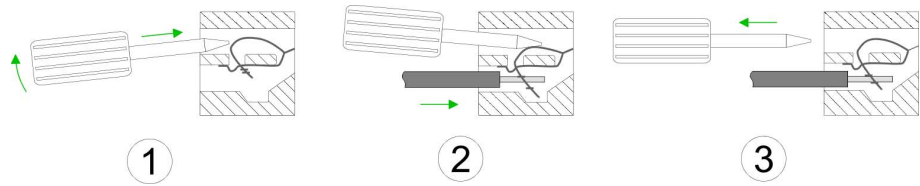

Shield attachment

1. Insert a suited screwdriver at an angle into the square opening as shown. Press and hold the screwdriver in the opposite direction to open the contact spring.
2. Insert the stripped end of wire into the round opening. You can use wires with a cross section of 0.08mm² up to 1.5mm²
3. By removing the screwdriver, the wire is securely fixed via the spring contact to the terminal.

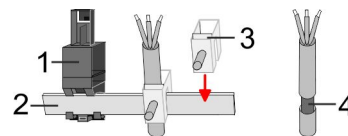

- 1 Shield bus carrier
- 2 Shield bus (10mm x 3mm)
- 3 Shield clamp
- 4 Cable shield

To attach the shield the mounting of shield bus carriers are necessary. The shield bus carrier (available as accessory) serves to carry the shield bus to connect cable shields.

1. Each System SLIO module has a carrier hole for the shield bus carrier. Push the shield bus carrier, until they engage into the module. With a flat mounting rail for adaptation to a flat mounting rail you may remove the spacer of the shield bus carrier.
2. Put your shield bus into the shield bus carrier.

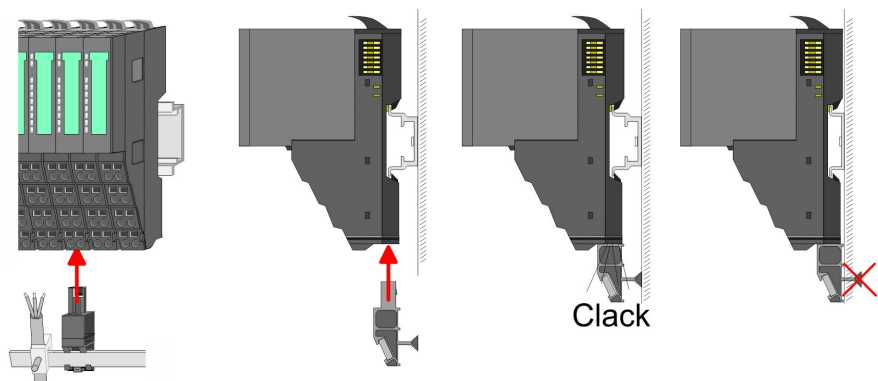

3. Attach the cables with the accordingly stripped cable screen and fix it by the shield clamp with the shield bus.

2.5.3 Wiring power modules

Terminal module terminals

Power modules are either integrated to the head module or may be installed between the periphery modules. With power modules, terminals with spring clamp technology are used for wiring. The spring clamp technology allows quick and easy connection of your signal and supply lines. In contrast to screw terminal connections this type of connection is vibration proof.

Data

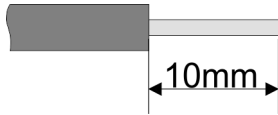

U_{max}	240V AC / 30V DC
I_{max}	10A
Cross section	0.08 ... 1.5mm ² (AWG 28 ... 16)
Stripping length	10mm

Wiring procedure

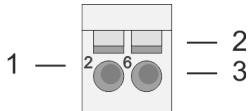

- 1 Pin number at the connector
- 2 Opening for screwdriver
- 3 Connection hole for wire

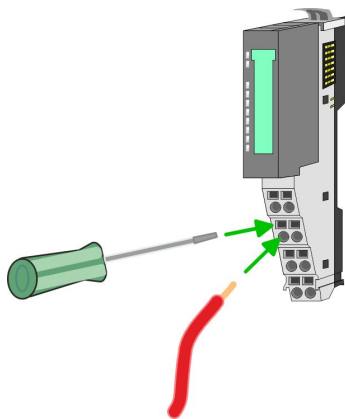
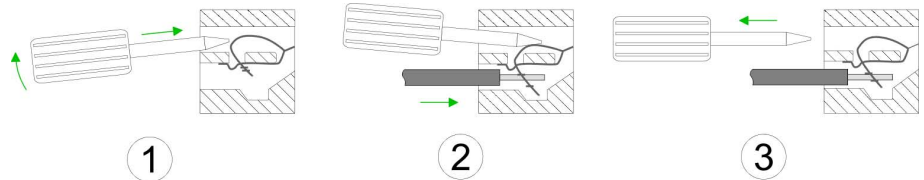

1. ▶ Insert a suited screwdriver at an angle into the square opening as shown. Press and hold the screwdriver in the opposite direction to open the contact spring.
2. ▶ Insert the stripped end of wire into the round opening. You can use wires with a cross section of 0.08mm² up to 1.5mm²
3. ▶ By removing the screwdriver, the wire is securely fixed via the spring contact to the terminal.

Standard wiring

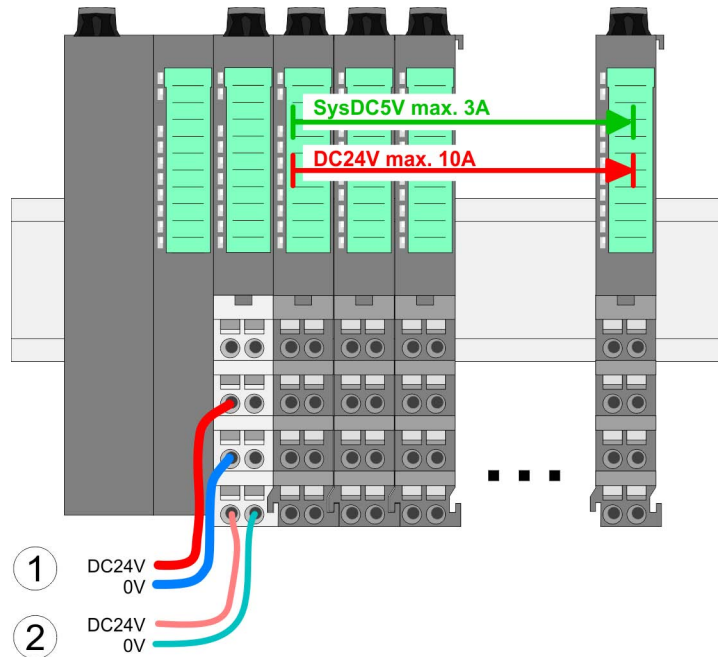

- (1) DC 24V for power section supply I/O area (max. 10A)
- (2) DC 24V for electronic power supply bus coupler and I/O area

PM - Power module

For wires with a core cross-section of 0.08mm² up to 1.5mm².

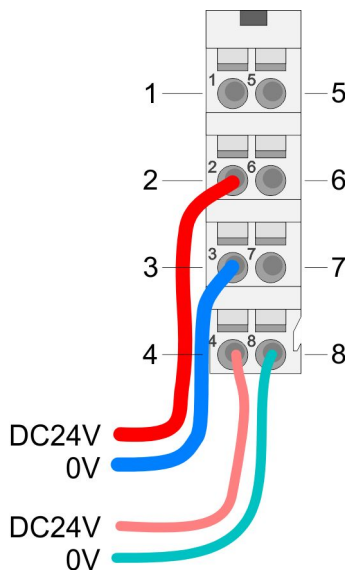

Pos.	Function	Type	Description
1	---	---	not connected
2	DC 24V	I	DC 24V for power section supply
3	0V	I	GND for power section supply
4	Sys DC 24V	I	DC 24V for electronic section supply
5	---	---	not connected
6	DC 24V	I	DC 24V for power section supply
7	0V	I	GND for power section supply
8	Sys 0V	I	GND for electronic section supply

I: Input



CAUTION!

Since the power section supply is not internally protected, it is to be externally protected with a fuse, which corresponds to the maximum current. This means max. 10A is to be protected by a 10A fuse (fast) respectively by a line circuit breaker 10A characteristics Z!



The electronic power section supply is internally protected against higher voltage by fuse. The fuse is within the power module. If the fuse releases, its electronic module must be exchanged!

Fusing

- The power section supply is to be externally protected with a fuse, which corresponds to the maximum current. This means max. 10A is to be protected with a 10A fuse (fast) respectively by a line circuit breaker 10A characteristics Z!
- It is recommended to externally protect the electronic power supply for head modules and I/O area with a 2A fuse (fast) respectively by a line circuit breaker 2A characteristics Z.
- The electronic power supply for the I/O area of the power module 007-1AB10 should also be externally protected with a 1A fuse (fast) respectively by a line circuit breaker 1A characteristics Z.

State of the electronic power supply via LEDs

After PowerON of the System SLIO the LEDs RUN respectively MF get on so far as the sum current does not exceed 1A. With a sum current greater than 1A the LEDs may not be activated. Here the power module with the order number 007-1AB10 is to be placed between the peripheral modules.

Deployment of the power modules

- If the 10A for the power section supply is no longer sufficient, you may use the power module from VIPA with the order number 007-1AB00. So you have also the possibility to define isolated groups.
- The power module with the order number 007-1AB10 is to be used if the 3A for the electronic power supply at the backplane bus is no longer sufficient. Additionally you get an isolated group for the DC 24V power section supply with max. 4A.
- By placing the power module 007-1AB10 at the following backplane bus modules may be placed with a sum current of max. 2A. Afterwards a power module is to be placed again. To secure the power supply, the power modules may be mixed used.

Power module 007-1AB00

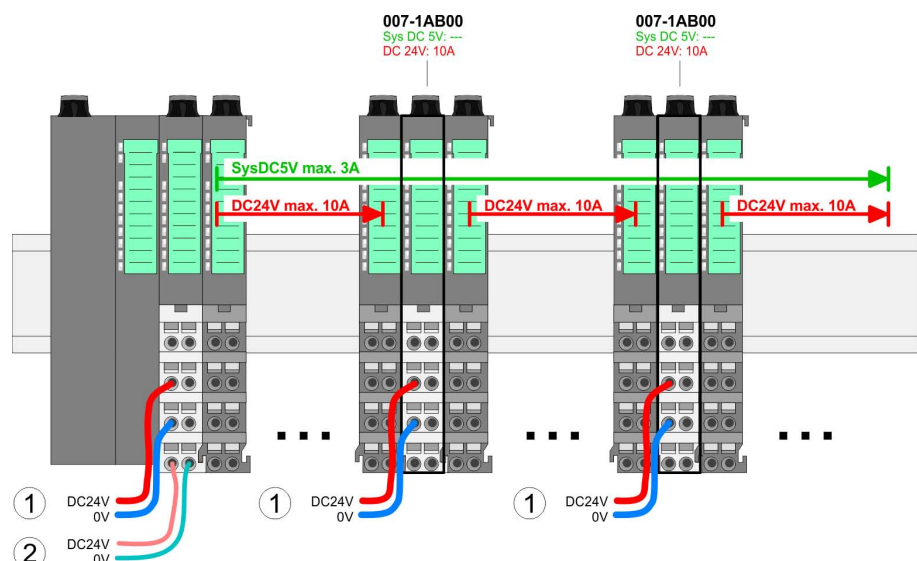

**Power module
007-1AB10**

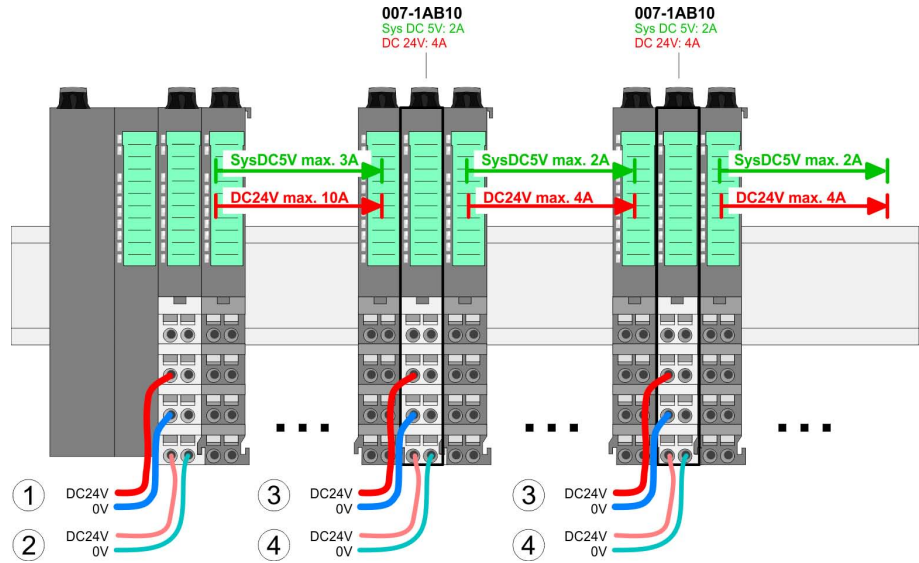

- (1) DC 24V for power section supply I/O area (max. 10A)
- (2) DC 24V for electronic power supply bus coupler and I/O area
- (3) DC 24V for power section supply I/O area (max. 4A)
- (4) DC 24V for electronic power supply I/O area

Shield attachment

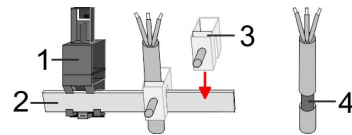

- 1 Shield bus carrier
- 2 Shield bus (10mm x 3mm)
- 3 Shield clamp
- 4 Cable shield

To attach the shield the mounting of shield bus carriers are necessary. The shield bus carrier (available as accessory) serves to carry the shield bus to connect cable shields.

- 1. Each System SLIO module has a carrier hole for the shield bus carrier. Push the shield bus carrier, until they engage into the module. With a flat mounting rail for adaptation to a flat mounting rail you may remove the spacer of the shield bus carrier.
- 2. Put your shield bus into the shield bus carrier.

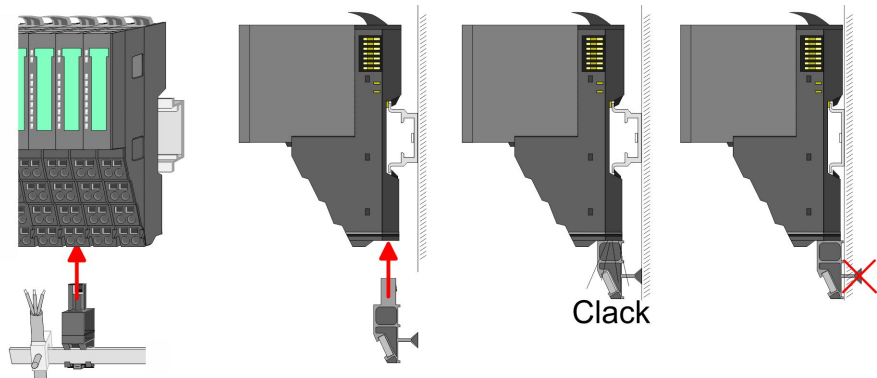

- 3. Attach the cables with the accordingly stripped cable screen and fix it by the shield clamp with the shield bus.

2.6 Demounting

2.6.1 Demounting CPU 01xC

Proceeding

Remove connector

By means of a screwdriver there is the possibility to remove the connectors e.g. for module exchange with a fix wiring. For this each connector has a release lever centrally on its top side. Unlocking takes place by the following proceeding:

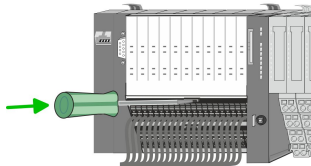

1. ► Power-off your system.

2. ► Remove connector:

Push your screwdriver horizontally into the slot between connector and release lever, until it stops.

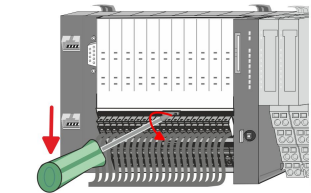

3. ► Push the screwdriver down

⇒ The connector is unlocked and can be removed by turning downwards.



CAUTION!

Via wrong operation such as pressing, the screwdriver upward the release lever may be damaged.

CPU replacement

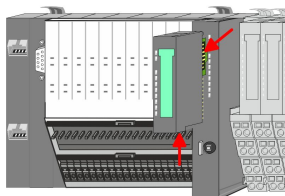

1. ►



For demounting and exchange of a (head) module or a group of modules, due to mounting reasons you always have to remove the electronic module right beside. After mounting it may be plugged again.

Press the unlocking lever at the lower side of the just mounted right module and pull it forward.

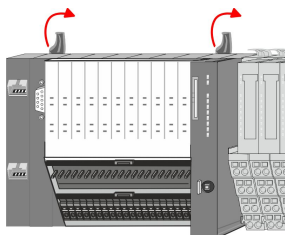

2. ► Turn all the locking lever of the CPU to be exchanged upwards.

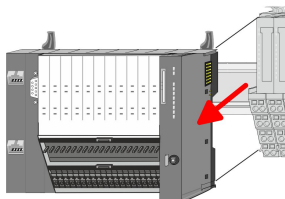

3. ► Pull the CPU forward.

4. ► For mounting turn all the locking lever of the CPU to be mounted upwards.

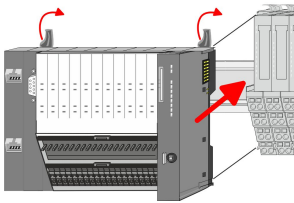

5. ▶ To mount the CPU put it to the peripheral module and push it, guided by the stripes, to the mounting rail.
6. ▶ Turn all the locking lever downward, again.

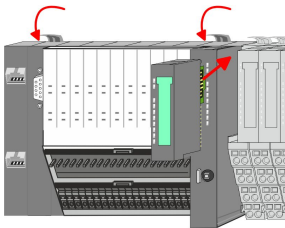

7. ▶ Plug again the electronic module, which you have removed before. For installation plug the electronic module guided by the strips at the lower side until this engages to the terminal module.

Plug connector

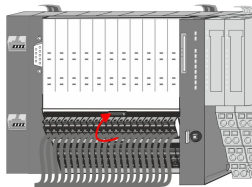

- ▶ Put the connector on the bottom edge and push it, as shown in the figure, with a rotation upwards into the release lever until it engages.
- ⇒ Now you can bring your system back into operation.

2.6.2 Demounting periphery modules

Proceeding

Exchange of an electronic module

1. ▶ Power-off your system.

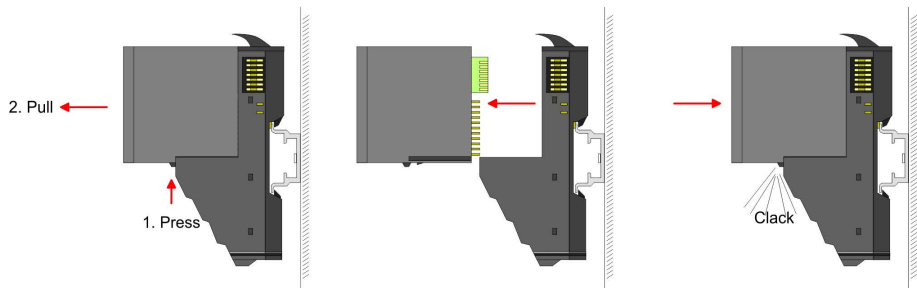

2. ▶ For the exchange of a electronic module, the electronic module may be pulled forward after pressing the unlocking lever at the lower side of the module.
3. ▶ For installation plug the new electronic module guided by the strips at the lower side until this engages to the terminal module.
- ⇒ Now you can bring your system back into operation.

Exchange of a periphery module

1. ▶ Power-off your system.
2. ▶ Remove if exists the wiring of the module.

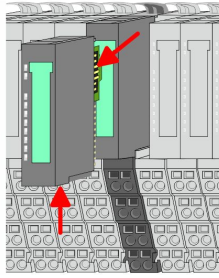

3. ▶



For demounting and exchange of a (head) module or a group of modules, due to mounting reasons you always have to remove the electronic module right beside. After mounting it may be plugged again.

Press the unlocking lever at the lower side of the just mounted right module and pull it forward.

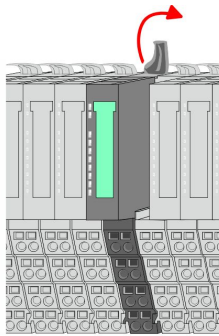

4. ▶

Turn the locking lever of the module to be exchanged upwards.

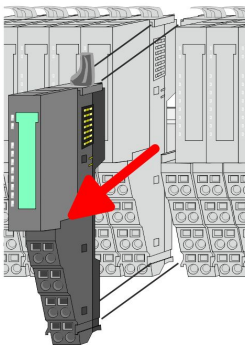

5. ▶

Pull the module.

6. ▶

For mounting turn the locking lever of the module to be mounted upwards.

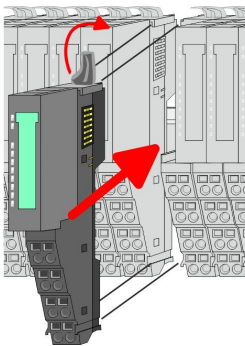

7. ▶

To mount the module put it to the gap between the both modules and push it, guided by the stripes at both sides, to the mounting rail.

8. ▶

Turn the locking lever downward, again.

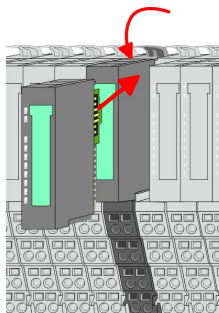

9. ▶

Plug again the electronic module, which you have removed before.

10. ▶

Wire your module.

⇒ Now you can bring your system back into operation.

Exchange of a module group

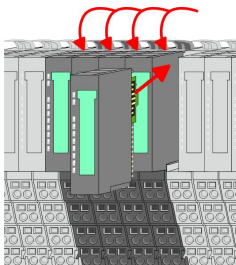
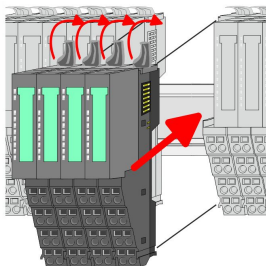
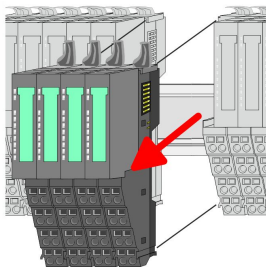
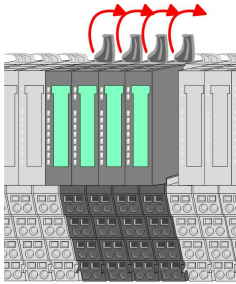
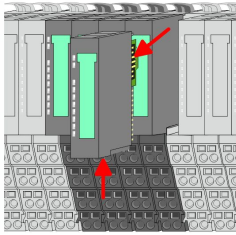

1. ▶ Power-off your system.
2. ▶ Remove if exists the wiring of the module group.
3. ▶

i For demounting and exchange of a (head) module or a group of modules, due to mounting reasons you always have to remove the electronic module right beside. After mounting it may be plugged again.

Press the unlocking lever at the lower side of the just mounted right module near the module group and pull it forward.

4. ▶ Turn all the locking lever of the module group to be exchanged upwards.
5. ▶ Pull the module group forward.
6. ▶ For mounting turn all the locking lever of the module group to be mounted upwards.

7. ▶ To mount the module group put it to the gap between the both modules and push it, guided by the stripes at both sides, to the mounting rail.
8. ▶ Turn all the locking lever downward, again.

9. ▶ Plug again the electronic module, which you have removed before.
10. ▶ Wire your module group.
 - ⇒ Now you can bring your system back into operation.

2.7 Trouble shooting - LEDs

General

Each module has the LEDs RUN and MF on its front side. Errors or incorrect modules may be located by means of these LEDs.

In the following illustrations flashing LEDs are marked by ☼.

Sum current of the electronic power supply exceeded

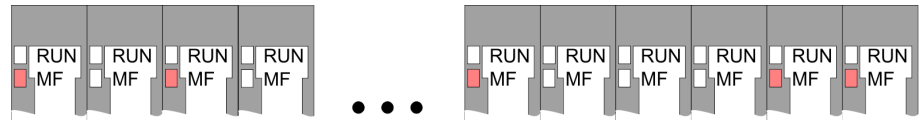

Behaviour: After PowerON the RUN LED of each module is off and the MF LED of each module is sporadically on.

Reason: The maximum current for the electronic power supply is exceeded.

Remedy: As soon as the sum current of the electronic power supply is exceeded, always place the power module 007-1AB10.

Error in configuration

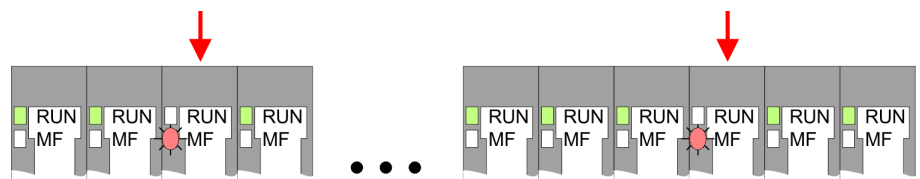

Behaviour: After PowerON the MF LED of one module respectively more modules flashes. The RUN LED remains off.

Reason: At this position a module is placed, which does not correspond to the configured module.

Remedy: Match configuration and hardware structure.

Module failure

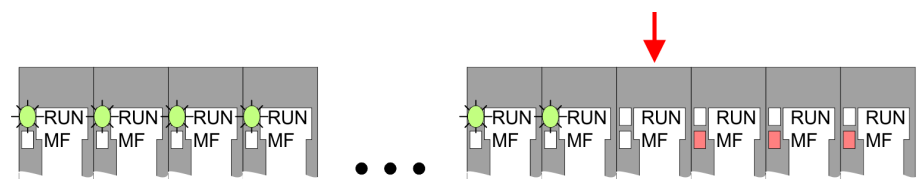

Behaviour: After PowerON all of the RUN LEDs up to the defective module are flashing. With all following modules the MF LED is on and the RUN LED is off.

Reason: The module on the right of the flashing modules is defective.

Remedy: Replace the defective module.

2.8 Installation guidelines

General

The installation guidelines contain information about the interference free deployment of a PLC system. There is the description of the ways, interference may occur in your PLC, how you can make sure the electromagnetic compatibility (EMC), and how you manage the isolation.

What does EMC mean?

Electromagnetic compatibility (EMC) means the ability of an electrical device, to function error free in an electromagnetic environment without being interfered respectively without interfering the environment.

The components of VIPA are developed for the deployment in industrial environments and meets high demands on the EMC. Nevertheless you should project an EMC planning before installing the components and take conceivable interference causes into account.

Possible interference causes

Electromagnetic interferences may interfere your control via different ways:

- Electromagnetic fields (RF coupling)
- Magnetic fields with power frequency
- Bus system
- Power supply
- Protected earth conductor

Depending on the spreading medium (lead bound or lead free) and the distance to the interference cause, interferences to your control occur by means of different coupling mechanisms.

There are:

- galvanic coupling
- capacitive coupling
- inductive coupling
- radiant coupling

Basic rules for EMC

In the most times it is enough to take care of some elementary rules to guarantee the EMC. Please regard the following basic rules when installing your PLC.

- Take care of a correct area-wide grounding of the inactive metal parts when installing your components.
 - Install a central connection between the ground and the protected earth conductor system.
 - Connect all inactive metal extensive and impedance-low.
 - Please try not to use aluminium parts. Aluminium is easily oxidizing and is therefore less suitable for grounding.
- When cabling, take care of the correct line routing.
 - Organize your cabling in line groups (high voltage, current supply, signal and data lines).
 - Always lay your high voltage lines and signal respectively data lines in separate channels or bundles.
 - Route the signal and data lines as near as possible beside ground areas (e.g. suspension bars, metal rails, tin cabinet).
- Proof the correct fixing of the lead isolation.
 - Data lines must be laid isolated.
 - Analog lines must be laid isolated. When transmitting signals with small amplitudes the one sided laying of the isolation may be favourable.
 - Lay the line isolation extensively on an isolation/protected earth conductor rail directly after the cabinet entry and fix the isolation with cable clamps.
 - Make sure that the isolation/protected earth conductor rail is connected impedance-low with the cabinet.
 - Use metallic or metallised plug cases for isolated data lines.

- In special use cases you should appoint special EMC actions.
 - Consider to wire all inductivities with erase links.
 - Please consider luminescent lamps can influence signal lines.
- Create a homogeneous reference potential and ground all electrical operating supplies when possible.
 - Please take care for the targeted employment of the grounding actions. The grounding of the PLC serves for protection and functionality activity.
 - Connect installation parts and cabinets with your PLC in star topology with the isolation/protected earth conductor system. So you avoid ground loops.
 - If there are potential differences between installation parts and cabinets, lay sufficiently dimensioned potential compensation lines.

Isolation of conductors

Electrical, magnetically and electromagnetic interference fields are weakened by means of an isolation, one talks of absorption. Via the isolation rail, that is connected conductive with the rack, interference currents are shunt via cable isolation to the ground. Here you have to make sure, that the connection to the protected earth conductor is impedance-low, because otherwise the interference currents may appear as interference cause.

When isolating cables you have to regard the following:

- If possible, use only cables with isolation tangle.
- The hiding power of the isolation should be higher than 80%.
- Normally you should always lay the isolation of cables on both sides. Only by means of the both-sided connection of the isolation you achieve high quality interference suppression in the higher frequency area. Only as exception you may also lay the isolation one-sided. Then you only achieve the absorption of the lower frequencies. A one-sided isolation connection may be convenient, if:
 - the conduction of a potential compensating line is not possible.
 - analog signals (some mV respectively μA) are transferred.
 - foil isolations (static isolations) are used.
- With data lines always use metallic or metallised plugs for serial couplings. Fix the isolation of the data line at the plug rack. Do not lay the isolation on the PIN 1 of the plug bar!
- At stationary operation it is convenient to strip the insulated cable interruption free and lay it on the isolation/protected earth conductor line.
- To fix the isolation tangles use cable clamps out of metal. The clamps must clasp the isolation extensively and have well contact.
- Lay the isolation on an isolation rail directly after the entry of the cable in the cabinet. Lead the isolation further on to your PLC and don't lay it on there again!



CAUTION!

Please regard at installation!

At potential differences between the grounding points, there may be a compensation current via the isolation connected at both sides.

Remedy: Potential compensation line

General data

2.9 General data

Conformity and approval		
Conformity		
CE	2014/35/EU	Low-voltage directive
	2014/30/EU	EMC directive
Approval		
UL		Refer to Technical data
others		
RoHS	2011/65/EU	Product is lead-free; Restriction of the use of certain hazardous substances in electrical and electronic equipment

Protection of persons and device protection		
Type of protection	-	IP20
Electrical isolation		
to the field bus	-	electrically isolated
to the process level	-	electrically isolated
Insulation resistance		-
Insulation voltage to reference earth		
Inputs / outputs	-	AC / DC 50V, test voltage AC 500V
Protective measures	-	against short circuit

Environmental conditions to EN 61131-2		
Climatic		
Storage / transport	EN 60068-2-14	-25...+70°C
Operation		
Horizontal installation hanging	EN 61131-2	0...+60°C
Horizontal installation lying	EN 61131-2	0...+60°C
Vertical installation	EN 61131-2	0...+60°C
Air humidity	EN 60068-2-30	RH1 (without condensation, rel. humidity 10...95%)
Pollution	EN 61131-2	Degree of pollution 2
Installation altitude max.	-	2000m
Mechanical		
Oscillation	EN 60068-2-6	1g, 9Hz ... 150Hz
Shock	EN 60068-2-27	15g, 11ms

Mounting conditions

Mounting place	-	In the control cabinet
Mounting position	-	Horizontal and vertical

EMC	Standard	Comment
Emitted interference	EN 61000-6-4	Class A (Industrial area)
Noise immunity zone B	EN 61000-6-2	Industrial area
	EN 61000-4-2	ESD 8kV at air discharge (degree of severity 3), 4kV at contact discharge (degree of severity 2)
	EN 61000-4-3	HF field immunity (casing) 80MHz ... 1000MHz, 10V/m, 80% AM (1kHz) 1.4GHz ... 2.0GHz, 3V/m, 80% AM (1kHz) 2GHz ... 2.7GHz, 1V/m, 80% AM (1kHz)
	EN 61000-4-6	HF conducted 150kHz ... 80MHz, 10V, 80% AM (1kHz)
	EN 61000-4-4	Burst, degree of severity 3
	EN 61000-4-5	Surge, installation class 3 *

*) Due to the high-energetic single pulses with Surge an appropriate external protective circuit with lightning protection elements like conductors for lightning and overvoltage is necessary.

3 Hardware description

3.1 Properties

CPU 013-CCF0R00

- SPEED7 technology integrated
- Programmable via VIP A SPEED7 Studio or Siemens SIMATIC Manager
- Integrated work memory 64kbyte (32kbyte code, 32kbyte data)
- Work memory expandable up to 128kbyte (64kbyte code, 64kbyte data)
- 128kbyte load memory integrated
- Slot for external storage media (lockable)
- Status LEDs for operating state and diagnostics
- X1/X2: Ethernet PG/OP channel (switch) integrated
- X3: MPI(PtP) interface: Serial integrated interface for MPI communication switchable to PtP communication with the protocols: ASCII, STX/ETX , USS, 3964(R), MODBUS RTU, master/slave
 - DPS interface: Interface with via VSC unlock able field bus functions (PROFIBUS slave)
- Integrated Digital IOs: DI 16xDC24V; DO 12xDC24V, 0,5A
- Integrated Analog Input : AI 2x12Bit (single ended)
- 4 channels for counter, frequency measurement and 2 channels for pulse width modulation
- up to 64 SLIO modules placeable
- I/O address area digital/analog 2048byte
- 512 timer/counter, 8192 flag byte

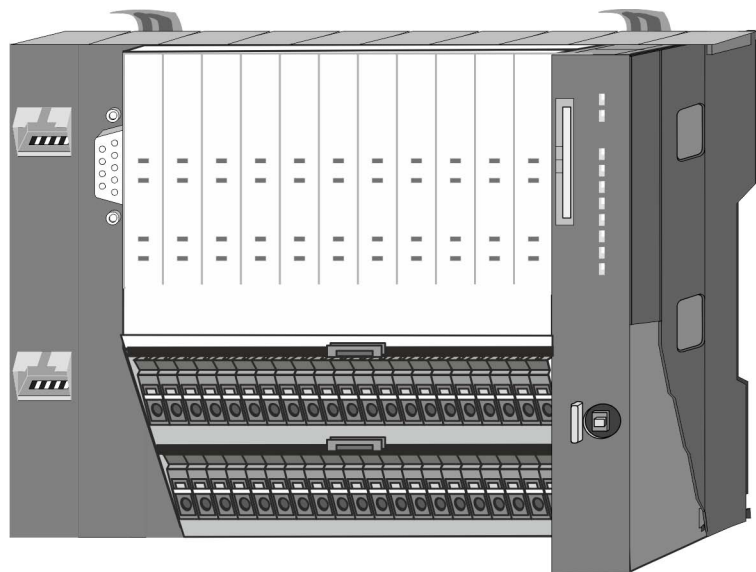

Ordering data

Type	Order number	Description
CPU 013C	013-CCF0R00	Compact CPU 013C with options to extend work memory and Field bus interface with DI 16xDC24V, DO 12xDC24V, 0.5A, AI 2x12Bit and 4 channels technological function

3.2 Structure

3.2.1 Compact CPU

CPU 013C

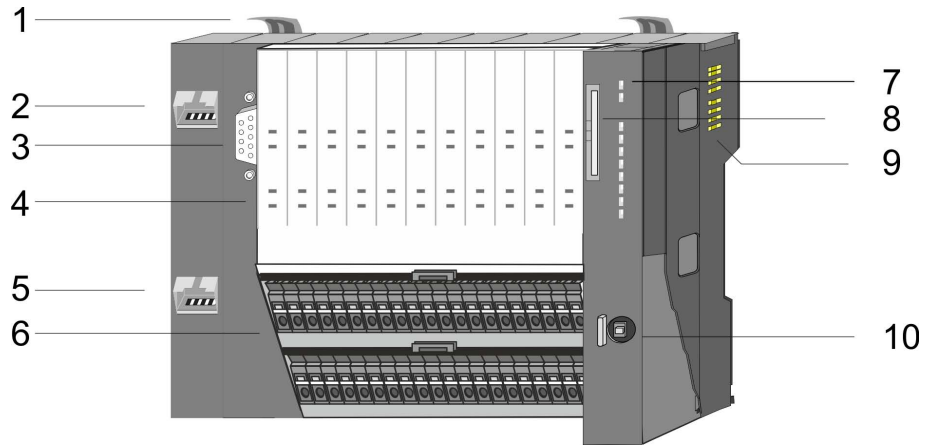

- 1 Locking lever
- 2 X1: Ethernet PG/OP channel 1
- 3 X3: MPI(PtP) interface
- 4 LEDs integrated IO peripheral
- 5 X2: Ethernet PG/OP channel 2
- 6 X4, X5: Connector IO part
- 7 LED status indication CPU part
- 8 Slot for external storage media (lockable)
- 9 Backplane bus
- 10 Operating mode switch CPU

3.2.2 Interfaces

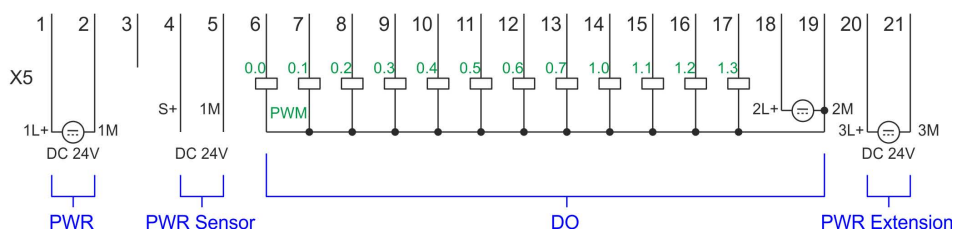
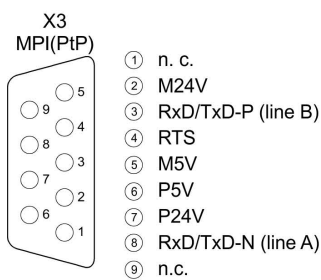
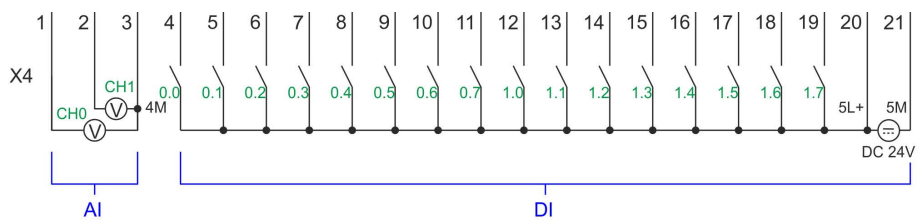
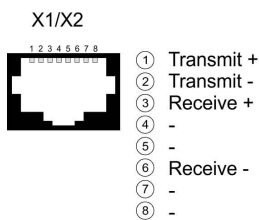

X1/X2: Ethernet PG/OP channel 1/2**8pin RJ45 jack:**

- The RJ45 jack serves as interface to the Ethernet PG/OP channel.
- This interface allows you to program respectively remote control your CPU and to access the internal web server.
- Configurable connections are not possible.
- For online access to the CPU via Ethernet PG/OP channel, you have to assign IP address parameters to this.

↪ *'Hardware configuration - Ethernet PG/OP channel' on page 64*

X3: MPI(PtP) interface**9pin SubD jack: (isolated)**

The interface supports the following functionalities, which are switchable:

- MPI (default / after overall reset)
The MPI interface serves for the connection between programming unit and CPU. By means of this the project engineering and programming happens. In addition MPI serves for communication between several CPUs or between HMIs and CPU. Standard setting is MPI address 2.
- PtP
The RS485 interface can be switched to PtP functionality ↪ *'Setting VIP A specific CPU parameters' on page 70*. Using the PtP functionality the RS485 interface is allowed to connect via serial point-to-point connection to different source res. target systems. The following protocols are supported:
 - ASCII
 - STX/ETX
 - 3964R
 - USS
 - Modbus master (ASCII, RTU)
- PROFIBUS DP slave (option)
The PROFIBUS slave functionality of this interface can be activated by configuring the sub module *'MPI/DP'* of the CPU in the hardware configuration. ↪ *'Option: PROFIBUS communication' on page 222*



*To switch the interface X3 MPI(PtP) to PROFIBUS functionality you have to activate the according bus functionality by means of a VSC storage media from VIP A. By plugging the VSC storage card and then an overall reset the according functionality is activated. ↪ *'Deployment storage media - VSD, VSC' on page 85**

X4: Connector

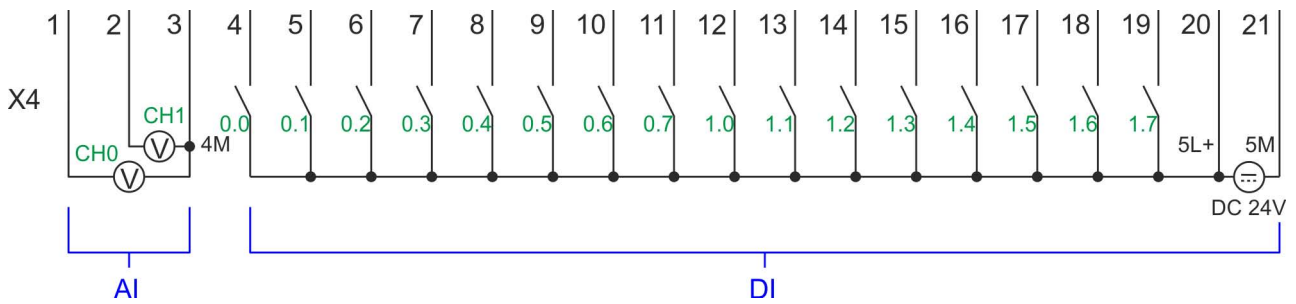

Pos.	Function	Type	Description
1	AI 0	I	AI0: Analog input AI 0
2	AI 1	I	AI1: Analog input AI 1
3	Analog 0V	I	4M: GND for analog inputs
4	DI 0	I	+0.0: Digital input DI 0 / Counter 0 (A) *
5	DI 1	I	+0.1: Digital input DI 1 / Counter 0 (B) / Frequency 0 *
6	DI 2	I	+0.2: Digital input DI 2
7	DI 3	I	+0.3: Digital input DI 3 / Counter 1 (A) *
8	DI 4	I	+0.4: Digital input DI 4 / Counter 1 (B) / Frequency 1 *
9	DI 5	I	+0.5: Digital input DI 5
10	DI 6	I	+0.6: Digital input DI 6 / Counter 2 (A) *
11	DI 7	I	+0.7: Digital input DI 7 / Counter 2 (B) / Frequency 2 *
12	DI 8	I	+1.0: Digital input DI 8
13	DI 9	I	+1.1: Digital input DI 9 / Counter 3 (A) *
14	DI 10	I	+1.2: Digital input DI 10 / Counter 3 (B) / Frequency 3 *
15	DI 11	I	+1.3: Digital input DI 11 / Gate 3 *
16	DI 12	I	+1.4: Digital input DI 12
17	DI 13	I	+1.5: Digital input DI 13
18	DI 14	I	+1.6: Digital input DI 14
19	DI 15	I	+1.7: Digital input DI 15 / Latch 3 *
20	DC 24V	I	5L+: DC 24V for onboard DI power section supply
21	0 V	I	5M: GND for onboard DI power section supply

*) Max. input frequency 100kHz otherwise 1kHz.

X5: Connector

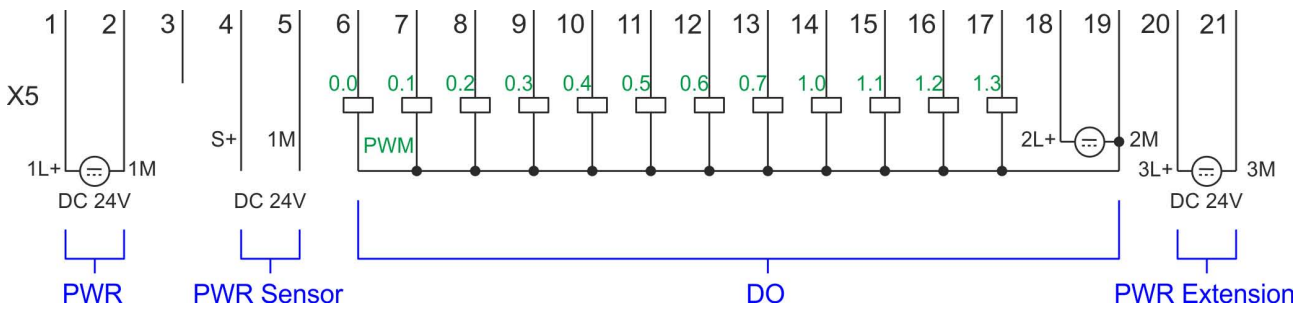

Pos.	Function	Type	Description
1	Sys DC 24V	I	1L+: DC 24V for electronic section supply
2	Sys 0V	I	1M: GND for electronic section supply
3	---	---	reserved
4	DC 24V	O	S+: DC 24V for sensor
5	0V	O	1M: GND for sensor
6	DO 0	O	+0.0: Digital output DO 0 / PWM 0 / Output channel counter 0
7	DO 1	O	+0.1: Digital output DO 1 / PWM 1 / Output channel counter 1
8	DO 2	O	+0.2: Digital output DO 2 / Output channel counter 2
9	DO 3	O	+0.3: Digital output DO 3 / Output channel counter 3
10	DO 4	O	+0.4: Digital output DO 4
11	DO 5	O	+0.5: Digital output DO 5
12	DO 6	O	+0.6: Digital output DO 6
13	DO 7	O	+0.7: Digital output DO 7
14	DO 8	O	+1.0: Digital output DO 8
15	DO 9	O	+1.1: Digital output DO 9
16	DO 10	O	+1.2: Digital output DO 10
17	DO 11	O	+1.3: Digital output DO 11
18	DC 24V	I	2L+: DC 24V for onboard DO power section supply
19	0 V	I	2M: GND for onboard DO power section supply / GND PWM
20	DC 24V	I	3L+: DC 24V for SLIO bus power section supply
21	0 V	I	3M: GND for SLIO bus power section supply

X5: Electronic power supply

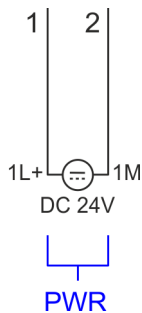

The CPU has an integrated power supply. The power supply has to be provided with DC 24V. Via the power supply not only the internal electronic of the CPU is provided with voltage, but also the electronic from the integrated IO modules and the sensor output. The power supply is protected against polarity inversion and over current.

3.2.3 Memory management

General

The CPU has an integrated memory. Information about the capacity of the memory may be found at the front of the CPU. The memory is divided into the following parts:

- Load memory 128kbyte
- Code memory (50% of the work memory)
- Data memory (50% of the work memory)
- Work memory 64kbyte
 - There is the possibility to extend the work memory to its maximum capacity 128kbyte by means of a VSC.

3.2.4 Slot for storage media

Overview

In this slot you can insert the following storage media:

- VSD - **VIPA SD-Card**
 - External memory card for programs and firmware.
- VSC - **VIPASetCard**
 - External memory card (VSD) for programs and firmware with the possibility to unlock optional functions like work memory and field bus interfaces.
 - These functions can be purchased separately. ↪ *Chapter 4.16 'Deployment storage media - VSD, VSC' on page 85*
 - To activate the corresponding card is to be installed and a *Overall reset* is to be established. ↪ *'Overall reset' on page 81*



A list of the currently available VSD respectively VSC can be found at www.vipa.com

3.2.5 Buffering mechanisms

The SLIO CPU has a capacitor-based mechanism to buffer the internal clock in case of power failure for max. 30 days. With PowerOFF the content of the RAM is automatically stored in the Flash (NVRAM).



CAUTION!

Please connect the CPU for approximately 1 hour to the power supply, so that the internal buffering mechanism is loaded accordingly.

In case of failure of the buffer mechanism Date and Time 01.09.2009 00:00:00 set. Additionally, you receive a diagnostics message. ↪ *'Diagnostic entries' on page 92*

3.2.6 Operating mode switch

General







- With the operating mode switch you may switch the CPU between STOP and RUN.
- During the transition from STOP to RUN the operating mode START-UP is driven by the CPU.
- Placing the switch to MR (**M**emory **R**eset), you request an overall reset with following load from memory card, if a project there exists.

3.2.7 LEDs

CPU part

PW		Meaning
green 	●	As soon as the CPU is supplied with 5V, the green PW-LED (Power) is on.
	○	The CPU is not power-supplied.

on: ● | off: ○

RN	ST	SF	FC	SD	Meaning
green 	yellow 	red 	yellow 	yellow 	

Boot-up after PowerON

●	X	BB	●	●	Flickers: Firmware is loaded.
●	●	●	●	●	Initialization: Phase 1
●	●	●	●	○	Initialization: Phase 2
●	●	●	○	○	Initialization: Phase 3
○	●	●	○	○	Initialization: Phase 4

Operation

○	●	X	X	X	CPU is in STOP state.
---	---	---	---	---	-----------------------

RN	ST	SF	FC	SD	Meaning
BB	○	X	X	X	CPU is in start-up state. Blinking with 2Hz: The RUN LED blinks during start-up (OB100) at least for 3s. During the processing of the OB 100 the STOP LED is on and then turns off.
○	BB	X	X	X	Blinking with 10Hz: Activation of a new hardware configuration
●	○	○	X	X	CPU is in state RUN without error.
X	X	●	X	X	There is a system fault. More information can be found in the diagnostics buffer of the CPU.
X	X	X	●	X	Variables are forced.
X	X	X	X	●	Accessing the memory card
X	BB	X	X	X	Blinking with 10Hz: Configuration is loaded
Overall reset					
○	BB	X	X	X	Blinking with 1Hz: Overall reset is requested
○	BB	X	X	X	Blinking with 2Hz: Overall reset is executed
○	BB	X	X	X	Blinking with 10Hz: Overall reset with default hardware configuration respectively with hardware configuration from memory card.
Reset to factory setting					
●	●	○	○	○	Reset to factory setting is executed
○	●	●	●	●	Reset to factory setting finished without error. Then a power cycle is necessary
Firmware update					
○	●	BB	BB	●	The alternate blinking indicates that there is new firmware on the memory card.
○	○	BB	BB	●	The alternate blinking indicates that a firmware update is executed.
○	●	●	●	●	Firmware update finished without error.
○	BB	BB	BB	BB	Blinking with 10Hz: Error during Firmware update.
on: ● off: ○ blinking: BB not relevant: X					

Ethernet PG/OP channel 1/2

L/A 1/2 (Link/Activity)	Meaning
green 	
●	The Ethernet PG/OP channel is physically connected to the Ethernet interface.
○	There is no physical connection.

Structure > LEDs



L/A 1/2 (Link/Activity)	Meaning
BB	Shows Ethernet activity.
•	The Ethernet interface of the Ethernet PG/OP channel has a transfer rate of 10Mbit.
on: • off: ○ blinking: BB not relevant: X	

**LEDs PROFIBUS inter-
face X3**





Optional

Dependent on the mode of operation the LEDs show information about the state of operation of the PROFIBUS part according to the following pattern:

Slave operation

DE (Data Exchange)	BF (Bus error)	Meaning
green 	red 	
○	○	Slave has no project.
○	•	There is a bus error.
BB	○	Slave is in state data exchange with master. Slave CPU is in STOP state.
•	○	Slave is in state data exchange with master. Slave CPU is in RUN state.
on: • off: ○ blinking (2Hz): BB		

I/O periphery

Digital input	LED  green	Description
DI +0.0 DI +0.7	●	Digital I+0.0 ... 0.7 has "1" signal
	○	Digital I+0.0 ... 0.7 has "0" signal
DI +1.0 ... DI +1.7	●	Digital I+1.0 ... 1.7 has "1" signal
	○	Digital input I+1.0 ... 1.7 has "0" signal
Digital output	LED  green	Description
DO +0.0 ... DO +0.7	●	Digital output Q+0.0 ... 0.7 has "1" signal
	○	Digital output Q+0.0 ... 0.7 has "0" signal
DO +1.0 ... DO +1.3	●	Digital output Q+1.0 ... 1.3 has "1" signal
	○	Digital output Q+1.0 ... 1.3 has "0" signal
Power supply	LED  green	Description
1L+	●	DC 24V electronic section supply
	○	DC 24V electronic section supply not available
2L+	●	DC 24V power section supply outputs OK
	○	DC 24V power section supply outputs OK
3L+	●	DC 24V power section supply SLIO bus OK
	○	DC 24V power section supply SLIO bus not available
5L+	●	DC 24V power section supply inputs OK
	○	DC 24V power section supply inputs not available
Error	LED  red	Description
1F	●	Error, overload respectively short circuit on power supply sensor
	○	no error
2F	●	Error, overload respectively short circuit on the outputs
	○	no error
on: ● off: ○		

3.3 Technical data

Order no.	013-CCF0R00
Type	CPU 013C
Module ID	-
Technical data power supply	
Power supply (rated value)	DC 24 V
Power supply (permitted range)	DC 20.4...28.8 V
Reverse polarity protection	✓
Current consumption (no-load operation)	120 mA
Current consumption (rated value)	360 mA
Inrush current	3 A
I^2t	0.1 A ² s
Max. current drain at backplane bus	1 A
Max. current drain load supply	6 A
Power loss	7 W
Technical data digital inputs	
Number of inputs	16
Cable length, shielded	1000 m
Cable length, unshielded	600 m
Rated load voltage	DC 24 V
Reverse polarity protection of rated load voltage	✓
Current consumption from load voltage L+ (without load)	25 mA
Rated value	DC 24 V
Input voltage for signal "0"	DC 0...5 V
Input voltage for signal "1"	DC 15...28.8 V
Input voltage hysteresis	-
Frequency range	-
Input resistance	-
Input current for signal "1"	3 mA
Connection of Two-Wire-BEROs possible	✓
Max. permissible BERO quiescent current	0.5 mA
Input delay of "0" to "1"	3 μ s – 15 ms / 0.5 ms – 15 ms
Input delay of "1" to "0"	3 μ s – 15 ms / 0.5 ms – 15 ms
Number of simultaneously utilizable inputs horizontal configuration	16
Number of simultaneously utilizable inputs vertical configuration	16

Order no.	013-CCF0R00
Input characteristic curve	IEC 61131-2, type 1
Initial data size	16 Bit
Technical data digital outputs	
Number of outputs	12
Cable length, shielded	1000 m
Cable length, unshielded	600 m
Rated load voltage	DC 24 V
Reverse polarity protection of rated load voltage	✓
Current consumption from load voltage L+ (without load)	20 mA
Total current per group, horizontal configuration, 40°C	6 A
Total current per group, horizontal configuration, 60°C	6 A
Total current per group, vertical configuration	6 A
Output voltage signal "1" at min. current	L+ (-0.8 V)
Output voltage signal "1" at max. current	L+ (-0.8 V)
Output current at signal "1", rated value	0.5 A
Output current, permitted range to 40°C	5 mA to 0.6 A
Output current, permitted range to 60°C	5 mA to 0.6 A
Output current at signal "0" max. (residual current)	0.5 mA
Output delay of "0" to "1"	2 µs / 30 µs
Output delay of "1" to "0"	3 µs / 175 µs
Minimum load current	-
Lamp load	10 W
Parallel switching of outputs for redundant control of a load	not possible
Parallel switching of outputs for increased power	not possible
Actuation of digital input	✓
Switching frequency with resistive load	max. 1000 Hz
Switching frequency with inductive load	max. 0.5 Hz
Switching frequency on lamp load	max. 10 Hz
Internal limitation of inductive shut-off voltage	L+ (-45 V)
Short-circuit protection of output	yes, electronic
Trigger level	1 A
Number of operating cycle of relay outputs	-

Technical data

Order no.	013-CCF0R00
Switching capacity of contacts	-
Output data size	12 Bit
Technical data analog inputs	
Number of inputs	2
Cable length, shielded	200 m
Rated load voltage	-
Reverse polarity protection of rated load voltage	-
Current consumption from load voltage L+ (without load)	-
Voltage inputs	✓
Min. input resistance (voltage range)	100 kΩ
Input voltage ranges	0 V ... +10 V
Operational limit of voltage ranges	+/-3.5%
Operational limit of voltage ranges with SFU	-
Basic error limit voltage ranges	+/-3.0%
Basic error limit voltage ranges with SFU	-
Destruction limit voltage	max. 30V
Current inputs	-
Max. input resistance (current range)	-
Input current ranges	-
Operational limit of current ranges	-
Operational limit of current ranges with SFU	-
Basic error limit current ranges	-
Radical error limit current ranges with SFU	-
Destruction limit current inputs (electrical current)	-
Destruction limit current inputs (voltage)	-
Resistance inputs	-
Resistance ranges	-
Operational limit of resistor ranges	-
Operational limit of resistor ranges with SFU	-
Basic error limit	-
Basic error limit with SFU	-
Destruction limit resistance inputs	-
Resistance thermometer inputs	-
Resistance thermometer ranges	-

Order no.	013-CCF0R00
Operational limit of resistance thermometer ranges	-
Operational limit of resistance thermometer ranges with SFU	-
Basic error limit thermoresistor ranges	-
Basic error limit thermoresistor ranges with SFU	-
Destruction limit resistance thermometer inputs	-
Thermocouple inputs	-
Thermocouple ranges	-
Operational limit of thermocouple ranges	-
Operational limit of thermocouple ranges with SFU	-
Basic error limit thermoelement ranges	-
Basic error limit thermoelement ranges with SFU	-
Destruction limit thermocouple inputs	-
Programmable temperature compensation	-
External temperature compensation	-
Internal temperature compensation	-
Technical unit of temperature measurement	-
Resolution in bit	12
Measurement principle	successive approximation
Basic conversion time	0.5 ms
Noise suppression for frequency	40 dB
Initial data size	4 Byte
Technical data analog outputs	
Number of outputs	-
Cable length, shielded	-
Rated load voltage	-
Reverse polarity protection of rated load voltage	-
Current consumption from load voltage L+ (without load)	-
Voltage output short-circuit protection	-
Voltage outputs	-
Min. load resistance (voltage range)	-
Max. capacitive load (current range)	-
Max. inductive load (current range)	-

Technical data

Order no.	013-CCF0R00
Output voltage ranges	-
Operational limit of voltage ranges	-
Basic error limit voltage ranges with SFU	-
Destruction limit against external applied voltage	-
Current outputs	-
Max. in load resistance (current range)	-
Max. inductive load (current range)	-
Typ. open circuit voltage current output	-
Output current ranges	-
Operational limit of current ranges	-
Radical error limit current ranges with SFU	-
Destruction limit against external applied voltage	-
Settling time for ohmic load	-
Settling time for capacitive load	-
Settling time for inductive load	-
Resolution in bit	-
Conversion time	-
Substitute value can be applied	-
Output data size	-
Technical data counters	
Number of counters	4
Counter width	32 Bit
Maximum input frequency	100 kHz
Maximum count frequency	400 kHz
Mode incremental encoder	✓
Mode pulse / direction	✓
Mode pulse	✓
Mode frequency counter	✓
Mode period measurement	✓
Gate input available	✓
Latch input available	✓
Reset input available	-
Counter output available	✓
Technical data sensor supply	
Output voltage typ.	1

Order no.	013-CCF0R00
Output voltage typ.	L+ (-1.5 V)
Output current, rated value	300 mA
Short-circuit protection of output	yes, electronic
Connection of potential area	Power supply of PLC
Load and working memory	
Load memory, integrated	128 KB
Load memory, maximum	128 KB
Work memory, integrated	64 KB
Work memory, maximal	128 KB
Memory divided in 50% program / 50% data	✓
Memory card slot	SD/MMC-Card with max. 2 GB
Hardware configuration	
Racks, max.	5
Modules per rack, max.	total max. 64 minus number line extensions
Number of integrated DP master	-
Number of DP master via CP	-
Operable function modules	64
Operable communication modules PtP	64
Operable communication modules LAN	-
Status information, alarms, diagnostics	
Status display	yes
Interrupts	yes
Process alarm	yes
Diagnostic interrupt	yes
Diagnostic functions	yes, parameterizable
Diagnostics information read-out	possible
Supply voltage display	green LED
Group error display	red SF LED
Channel error display	red LED per group
Isolation	
Between channels	✓
Between channels of groups to	16
Between channels and backplane bus	✓
Between channels and power supply	-
Max. potential difference between circuits	DC 75 V/ AC 50 V
Max. potential difference between inputs (U _{cm})	-

Technical data

Order no.	013-CCF0R00
Max. potential difference between Mana and Mintern (Uiso)	-
Max. potential difference between inputs and Mana (Ucm)	-
Max. potential difference between inputs and Mintern (Uiso)	-
Max. potential difference between Mintern and outputs	-
Insulation tested with	DC 500 V
Command processing times	
Bit instructions, min.	0.02 µs
Word instruction, min.	0.02 µs
Double integer arithmetic, min.	0.02 µs
Floating-point arithmetic, min.	0.12 µs
Timers/Counters and their retentive characteristics	
Number of S7 counters	512
Number of S7 times	512
Data range and retentive characteristic	
Number of flags	8192 Byte
Number of data blocks	1024
Max. data blocks size	64 KB
Max. local data size per execution level	4096 Byte
Blocks	
Number of OBs	22
Number of FBs	1024
Number of FCs	1024
Maximum nesting depth per priority class	16
Maximum nesting depth additional within an error OB	4
Time	
Real-time clock buffered	✓
Clock buffered period (min.)	30 d
Accuracy (max. deviation per day)	10 s
Number of operating hours counter	8
Clock synchronization	✓
Synchronization via MPI	Master/Slave
Synchronization via Ethernet (NTP)	no

Order no.	013-CCF0R00
Address areas (I/O)	
Input I/O address area	2048 Byte
Output I/O address area	2048 Byte
Input process image maximal	2048 Byte
Output process image maximal	2048 Byte
Digital inputs	528
Digital outputs	524
Digital inputs central	528
Digital outputs central	524
Integrated digital inputs	16
Integrated digital outputs	12
Analog inputs	514
Analog outputs	256
Analog inputs, central	514
Analog outputs, central	256
Integrated analog inputs	2
Integrated analog outputs	-
Number of outputs	1
Output voltage (typ)	L+ (-1.5 V)
Output voltage (rated value)	300 mA
Short-circuit protection	yes, electronic
Binding of potential	Power supply of PLC
Communication functions	
PG/OP channel	✓
Global data communication	✓
Number of GD circuits, max.	8
Size of GD packets, max.	54 Byte
S7 basic communication	✓
S7 basic communication, user data per job	76 Byte
S7 communication	✓
S7 communication as server	✓
S7 communication as client	-
S7 communication, user data per job	160 Byte
Number of connections, max.	32
PWM data	
PWM channels	2

Technical data

Order no.	013-CCF0R00
PWM time basis	1 µs / 0.1 ms / 1 ms
Period length	50µs...65.535ms / 0.1...87ms / 1...87ms
Minimum pulse width	0...0.5 * Period duration
Type of output	Highside
Functionality Sub-D interfaces	
Type	X3
Type of interface	RS485
Connector	Sub-D, 9-pin, female
Electrically isolated	✓
MPI	✓
MP ² I (MPI/RS232)	-
DP master	-
DP slave	optional
Point-to-point interface	✓
5V DC Power supply	max. 90mA, isolated
24V DC Power supply	max. 100mA, non-isolated
Functionality MPI	
Type	-
Type of interface	-
Connector	-
Electrically isolated	-
MPI	-
MP ² I (MPI/RS232)	-
DP master	-
DP slave	-
Point-to-point interface	-
5V DC Power supply	-
24V DC Power supply	-
Number of connections, max.	32
PG/OP channel	✓
Routing	✓
Global data communication	✓
S7 basic communication	✓
S7 communication	✓
S7 communication as server	✓

Order no.	013-CCF0R00
S7 communication as client	-
Transmission speed, min.	19.2 kbit/s
Transmission speed, max.	12 Mbit/s
Functionality PROFIBUS slave	
PG/OP channel	✓
Routing	✓
S7 communication	✓
S7 communication as server	✓
S7 communication as client	-
Direct data exchange (slave-to-slave communication)	-
DPV1	✓
Transmission speed, min.	9.6 kbit/s
Transmission speed, max.	12 Mbit/s
Automatic detection of transmission speed	✓
Transfer memory inputs, max.	244 Byte
Transfer memory outputs, max.	244 Byte
Address areas, max.	32
User data per address area, max.	32 Byte
Point-to-point communication	
PtP communication	✓
Interface isolated	✓
RS232 interface	-
RS422 interface	-
RS485 interface	✓
Connector	Sub-D, 9-pin, female
Transmission speed, min.	150 bit/s
Transmission speed, max.	115.5 kbit/s
Cable length, max.	500 m
Point-to-point protocol	
ASCII protocol	✓
STX/ETX protocol	✓
3964(R) protocol	✓
RK512 protocol	-
USS master protocol	✓
Modbus master protocol	✓

Technical data

Order no.	013-CCF0R00
Modbus slave protocol	✓
Special protocols	-
Functionality RJ45 interfaces	
Type	X1/X2
Type of interface	Ethernet 10/100 MBit Switch
Connector	2 x RJ45
Electrically isolated	✓
PG/OP channel	✓
Number of connections, max.	4
Productive connections	-
Type	-
Type of interface	-
Connector	-
Electrically isolated	-
PG/OP channel	-
Number of connections, max.	-
Productive connections	-
Housing	
Material	PPE / PPE GF10
Mounting	Profile rail 35 mm
Mechanical data	
Dimensions (WxHxD)	147 mm x 100 mm x 83 mm
Weight	310 g
Environmental conditions	
Operating temperature	0 °C to 60 °C
Storage temperature	-25 °C to 70 °C
Certifications	
UL certification	in preparation
KC certification	in preparation

4 Deployment CPU 013-CCF0R00

4.1 Assembly



Information about assembly and cabling ↪ 'Basics and mounting' on page 11.

4.2 Start-up behavior

Turn on power supply

- The CPU checks whether a project AUTOLOAD.WLD exists on the memory card. If so, an overall reset is executed and the project is automatically loaded from the memory card.
- The CPU checks whether a command file with the name VIPA_CMD.MMC exists on the memory card. If so the command file is loaded from the memory card and the commands are executed.
- After PowerON and CPU STOP the CPU checks if there is a *.pkg file (firmware file) on the memory card. If so, this is shown by the CPU by blinking LEDs and the firmware may be installed by an update request. ↪ *further information on page 84*
- The CPU checks if a previously activated VSC is inserted. If not, the SD LED gets on and a diagnostics entry is released. The CPU switches to STOP after 72 hours. With a just installed VSC activated functions remain activated. ↪ *'Diagnostic entries' on page 92*

After this the CPU switches to the operating mode, which is set on the operating mode switch.

Delivery state

In the delivery state the CPU is overall reset. After a STOP→RUN transition the CPU switches to RUN without program.

4.3 Addressing

4.3.1 Overview

To provide specific addressing of the installed peripheral modules, certain addresses must be allocated in the CPU. This address mapping is in the CPU as hardware configuration. If there is no hardware configuration, depending on the slot, the CPU assigns automatically peripheral addresses for digital in-/output modules starting with 0 and analog modules are assigned to even addresses starting with 256.

4.3.2 Default address assignment of the I/O part

Sub module	Input address	Access	Assignment
AI5/AO2	800	WORD	Analog input channel 0 (X4)
	802	WORD	Analog input channel 1 (X4)

Sub module	Input address	Access	Assignment
DI24/DO16	136	BYTE	Digital input I+0.0 ... I+0.7 (X4)
	137	BYTE	Digital input I+1.0 ... I+1.7 (X4)

Sub module	Input address	Access	Assignment
Counter	816	DINT	Channel 0: Counter value / Frequency value
	820	DINT	Channel 1: Counter value / Frequency value
	824	DINT	Channel 2: Counter value / Frequency value
	828	DINT	Channel 3: Counter value / Frequency value

Sub module	Output address	Access	Assignment
DI24/DO16	136	BYTE	Digital output Q+0.0 ... Q+0.7 (X5)
	137	BYTE	Digital output Q+1.0 ... Q+1.3 (X5)

Sub module	Output address	Access	Assignment
Counter	816	DWORD	reserved
	820	DWORD	reserved
	824	DWORD	reserved
	828	DWORD	reserved

4.3.3 Addressing periphery modules

The CPU 013-CCF0R00 provides an I/O area (address 0 ... 2047) and a process image of the in- and outputs (each address default 0 ... 127). The process image stores the signal states of the lower address (default 0 ... 127) in an additional memory area. The size of the process image can be preset via the parameterization. ↪ *'Setting standard CPU parameters' on page 66*

The process image is divided into two parts:

- process image to the inputs (PII)
- process image to the outputs (PIQ)

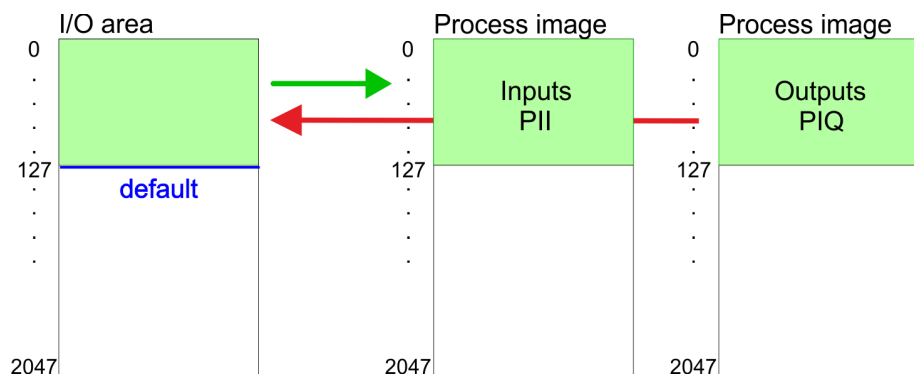

The process image is updated automatically when a cycle has been completed.

Max. number of plug-gable modules

Up to 64 SLIO modules can be connected to a SLIO CPU. This sum includes power and clamp modules.

Define addresses by hardware configuration

You may access the modules with read res. write accesses to the peripheral bytes or the process image. To define addresses a hardware configuration may be used. For this, click on the properties of the according module and set the wanted address.

Automatic addressing

If you do not like to use a hardware configuration, an automatic addressing is established. Here the address assignment follows the following specifications:

- Starting with slot 1, the central plugged modules are assigned with ascending logical addresses.
- The length of the memory area corresponds to the size of the process data of the according module. Information about the sizes of the process data can be found in the according manual of the module.
- The memory areas of the modules are assigned without gaps separately for input and output area.
- Digital modules are mapped starting at address 0 and all other modules are mapped starting from address 256. ETS modules are mapped starting from address 256.
- As soon as the mapping of digital modules exceeds the address 256, by regarding the order, these are mapped starting from address 256.

4.4 Hardware configuration - CPU

Precondition

- The configuration of the CPU takes place at the Siemens *'hardware configurator'*. The hardware configurator is part of the Siemens SIMATIC Manager. It serves for project engineering.
- Please use for configuration the Siemens SIMATIC Manager V 5.5 SP2 and up.
- The configuration of the System SLIO CPU happens in the Siemens SIMATIC Manager by means of a virtual PROFINET IO device *'VIPA SLIO CPU'*. The *'VIPA SLIO System'* is to be installed in the hardware catalog by means of the GSDML.



For project engineering a thorough knowledge of the Siemens SIMATIC Manager and the Siemens hardware configurator is required!

Installing the IO device VIPA SLIO System

The installation of the PROFINET IO devices *'VIPA SLIO CPU'* happens in the hardware catalog with the following approach:

1. ➤ Go to the service area of www.vipa.com.
2. ➤ Load from the download area at *'PROFINET files'* the file *System SLIO_Vxxx.zip*.
3. ➤ Extract the file into your working directory.

4. ▶ Start the Siemens hardware configurator.
5. ▶ Close all the projects.
6. ▶ Select *'Options → Install new GSD file'*
7. ▶ Navigate to your working directory and install the according GSDML file.
 - ⇒ After the installation according PROFINET IO device can be found at *'PROFINET IO → Additional field devices → I/O → VIPA SLIO System'*

Proceeding

In the Siemens SIMATIC Manager the following steps should be executed:

1. ▶ Start the Siemens hardware configurator with a new project.
2. ▶ Insert a profile rail from the hardware catalog.
3. ▶ Place at *'Slot'*-Number 2 the CPU 314C-2 PN/DP (314-6EH04-0AB0 V3.3).

Slot	Module
1	
2	CPU 314C-2PN/DP
X1	MPI/DP
X2	PN-IO
X2...	Port 1
X2...	Port 2
...	...
3	

4. ▶ Click at the sub module *'PN-IO'* of the CPU.
5. ▶ Select *'Context menu → Insert PROFINET IO System'*.

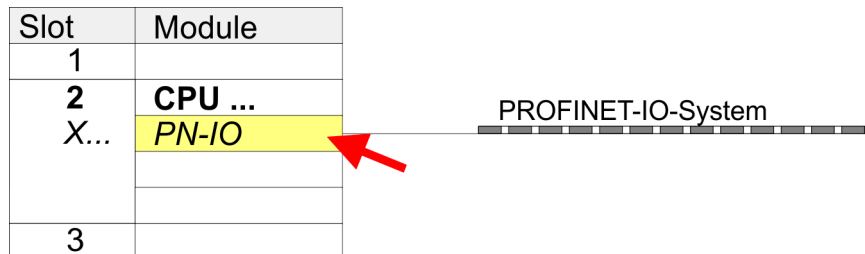

6. ▶ Create with [New] a new sub net and assign valid address data
7. ▶ Click at the sub module *'PN-IO'* of the CPU and open with *'Context menu → Properties'* the properties dialog.
8. ▶ Enter at *'General'* a device name. The device name must be unique at the Ethernet subnet.

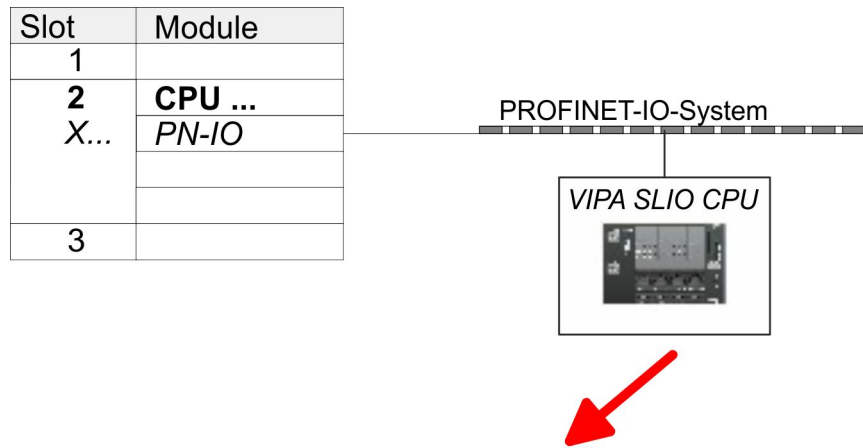

Slot	Module	Order number
0	VIPA SLIO CPU ...	013-CCF0R00
X2	<i>013-CCF0R00</i>	
1		
2		
3		
...		

9. ▶ Navigate in the hardware catalog to the directory 'PROFINET IO → Additional field devices → I/O → VIPA SLIO System' and connect the IO device '013-CCF0R00 CPU' to your PROFINET system.
 - ⇒ In the slot overview of the PROFINET IO device 'VIPA SLIO CPU' the CPU is already placed at slot 0. From slot 1 you can place your System SLIO modules.

4.5 Hardware configuration - System SLIO module

System SLIO backplane bus

To connect System SLIO modules, the CPU has a backplane bus, which must additionally to be supplied. Here up to 64 System SLIO modules can be connected.

Proceeding

1. ▶ Perform, if not already done, a hardware configuration for the CPU. ↪ 'Hardware configuration - CPU' on page 61
2. ▶ Starting with slot 1 place in the slot overview of the PROFINET IO device "VIPA SLIO CPU" your System SLIO modules in the plugged sequence.
3. ▶ Parametrize if necessary the modules and assign valid addresses, so that they can directly be addressed.

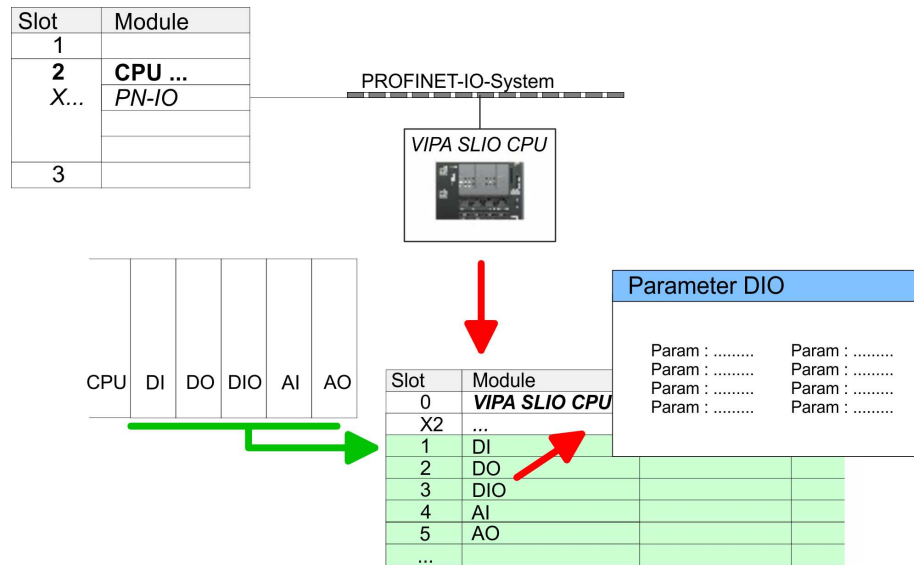

4.6 Hardware configuration - Ethernet PG/OP channel

Overview

The CPU has an integrated Ethernet PG/OP channel. This channel allows you to program and remote control your CPU.

- The Ethernet PG/OP channel (X1/X2) is designed as switch. This enables PG/OP communication via the connections X1 and X2.
- The Ethernet PG/OP channel also gives you access to the internal web page that contains information about firmware version, connected I/O devices, current cycle times etc.
- At the first commissioning respectively after a factory reset the Ethernet PG/OP channel has no IP address.
- For online access to the CPU via the Ethernet PG/OP channel, valid IP address parameters have to be assigned to this. This is called "initialization".
- This can be done with the Siemens SIMATIC Manager.

Assembly and commissioning

1. ➤ Install your System SLIO with your CPU.
2. ➤ Wire the system by connecting cables for voltage supply and signals.
3. ➤ Connect the one of the Ethernet jack (X1, X2) of the Ethernet PG/OP channel to Ethernet, to which your programming device (PC) is connected.
4. ➤ Switch on the power supply.
 - ⇒ After a short boot time the CPU is ready for communication. It possibly has no IP address data and requires an initialization.

"Initialization" via PLC functions

The initialization via PLC functions takes place with the following proceeding:

- Determine the current Ethernet (MAC) address of your Ethernet PG/OP channel. This can be found at the front of your CPU with the name "MAC PG/OP: ...".

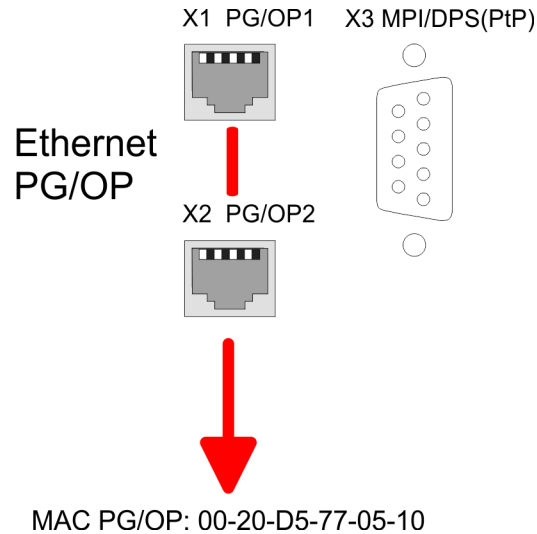

Assign IP address parameters

You get valid IP address parameters from your system administrator. The assignment of the IP address data happens online in the Siemens SIMATIC Manager starting with version V 5.3 & SP3 with the following proceeding:

1. ▶ Start the Siemens SIMATIC Manager and set via 'Options → Set PG/PC interface' the access path to 'TCP/IP -> Network card'.
2. ▶ Open with 'PLC → Edit Ethernet Node n' the dialog window with the same name.
3. ▶ To get the stations and their MAC address, use the [Browse] button or type in the MAC Address. The Mac address may be found at the 1. label beneath the front flap of the CPU.
4. ▶ Choose if necessary the known MAC address of the list of found stations.
5. ▶ Either type in the IP configuration like IP address, subnet mask and gateway.
6. ▶ Confirm with [Assign IP configuration].
 - ⇒ Direct after the assignment the Ethernet PG/OP channel may be reached online by these address data. The value remains as long as it is reassigned, it is overwritten by a hardware configuration or an factory reset is executed.

4.7 Hardware configuration - communication

The hardware configuration of PROFIBUS and PtP described at the following pages:

- PROFIBUS-DP
 - Slave operation: ↪ 'Option: PROFIBUS communication' on page 222
- PtP
 - PtP: ↪ 'Deployment PtP communication' on page 198

4.8 Setting standard CPU parameters

4.8.1 Parametrization via Siemens CPU

Parametrization via Siemens CPU 314-6EH04

Since the CPU from VIPA is to be configured as Siemens CPU 314C-2 PN/DP (6ES7 314-6EH04-0AB0 V3.3) in the Siemens hardware configurator, the standard parameters of the VIPA CPU may be set with "Object properties" of the CPU 314C-2 PN/DP during hardware configuration. Via a double-click on the CPU 314C-2 PN/DP the parameter window of the CPU may be accessed. Using the registers you get access to every standard parameter of the CPU.

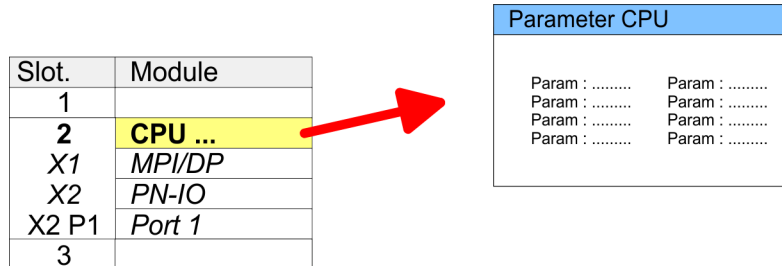

4.8.2 Parameter CPU

Supported parameters

The CPU does not evaluate each parameter, which may be set at the hardware configuration. The parameters of the following registers are not supported: Synchronous cycle interrupts, communication and web. The following parameters are currently supported:

General

- Short description
 - The short description of the Siemens CPU 314-6EH04 is CPU 314C-2 PN/DP.
- Order No. / Firmware
 - Order number and firmware are identical to the details in the "hardware catalog" window.
- Name
 - The Name field provides the short description of the CPU.
 - If you change the name the new name appears in the Siemens SIMATIC Manager.
- Plant designation
 - Here is the possibility to specify a plant designation for the CPU.
 - This plant designation identifies parts of the plant according to their function.
 - Its structure is hierarchic according to IEC 81346-1.
- Location designation
 - The location designation is part of the resource designation.
 - Here the exact location of your module within a plant may be specified.
- Comment
 - In this field information about the module may be entered.

Startup

- Startup when expected/actual configuration differs
 - If the checkbox for '*Startup when expected/actual configuration differ*' is deselected and at least one module is not located at its configured slot or if another type of module is inserted there instead, then the CPU does not switch to RUN mode and remains in STOP mode.
 - If the checkbox for '*Startup when expected/actual configuration differ*' is selected, then the CPU starts even if there are modules not located in their configured slots or if another type of module is inserted there instead, such as during an initial system start-up.
- Monitoring time for ready message by modules [100ms]
 - This operation specifies the maximum time for the ready message of every configured module after PowerON.
 - Here connected PROFIBUS DP slaves are also considered until they are parameterized.
 - If the modules do not send a ready message to the CPU by the time the monitoring time has expired, the actual configuration becomes unequal to the preset configuration.
- Monitoring time for transfer of parameters to modules [100ms]
 - The maximum time for the transfer of parameters to parameterizable modules.
 - Here connected PROFINET IO devices also considered until they are parameterized.
 - If not every module has been assigned parameters by the time this monitoring time has expired; the actual configuration becomes unequal to the preset configuration.

Cycle/Clock memory

- Update OB1 process image cyclically
 - This parameter is not relevant.
- Scan cycle monitoring time
 - Here the scan cycle monitoring time in milliseconds may be set.
 - If the scan cycle time exceeds the scan cycle monitoring time, the CPU enters the STOP mode.
 - Possible reasons for exceeding the time are:
 - Communication processes
 - a series of interrupt events
 - an error in the CPU program
- Minimum scan cycle time
 - This parameter is not relevant.
- Scan cycle load from Communication
 - Using this parameter you can control the duration of communication processes, which always extend the scan cycle time so it does not exceed a specified length.
 - If the cycle load from communication is set to 50%, the scan cycle time of OB 1 can be doubled. At the same time, the scan cycle time of OB 1 is still being influenced by asynchronous events (e.g. hardware interrupts) as well.
- Size of the process image input/output area
 - Here the size of the process image max. 2048 for the input/output periphery may be fixed (default: 256).

- OB85 call up at I/O access error
 - The preset reaction of the CPU may be changed to an I/O access error that occurs during the update of the process image by the system.
 - The VIPA CPU is preset such that OB 85 is not called if an I/O access error occurs and no entry is made in the diagnostic buffer either.
- Clock memory
 - Activate the check box if you want to use clock memory and enter the number of the memory byte.



The selected memory byte cannot be used for temporary data storage.

Retentive Memory

- Number of Memory bytes from MB0
 - Enter the number of retentive memory bytes from memory byte 0 onwards.
- Number of S7 Timers from T0
 - Enter the number of retentive S7 timers from T0 onwards. Each S7 timer occupies 2bytes.
- Number of S7 Counters from C0
 - Enter the number of retentive S7 counter from C0 onwards.
- Areas
 - This parameter is not supported.

Interrupts

- Priority
 - Here the priorities are displayed, according to which the hardware interrupt OBs are processed (hardware interrupt, time-delay interrupt, async. error interrupts).

Time-of-day interrupts

- Priority
 - This value is fixed to 2.
- Active
 - By enabling 'Active' the time-of-day interrupt function is enabled.
- Execution
 - Select how often the interrupts are to be triggered.
 - Intervals ranging from every minute to yearly are available. The intervals apply to the settings made for *start date* and *time*.
- Start date/time
 - Enter date and time of the first execution of the time-of-day interrupt.
- Process image partition
 - This parameter is not supported.

Cyclic interrupts

- Priority
 - Here the priorities may be specified according to which the corresponding cyclic interrupt is processed.
- Execution
 - Enter the time intervals in ms, in which the watchdog interrupt OBs should be processed.
 - The start time for the clock is when the operating mode switch is moved from STOP to RUN.
- Phase offset
 - Enter the delay time in ms for current execution for the watchdog interrupt. This should be performed if several watchdog interrupts are enabled.
 - Phase offset allows to distribute processing time for watchdog interrupts across the cycle.
- Process image partition
 - This parameter is not supported.

Diagnostics/Clock

- Report cause of STOP
 - Activate this parameter, if the CPU should report the cause of STOP to PG respectively OP on transition to STOP.
- Number of messages in the diagnostics buffer
 - This parameter is ignored. The CPU always has a diagnostics buffer (circular buffer) for 100 diagnostics messages.
- Synchronization type
 - Here you specify whether clock should synchronize other clocks or not.
 - as slave: The clock is synchronized by another clock.
 - as master: The clock synchronizes other clocks as master.
 - none: There is no synchronization
- Time interval
 - Time intervals within which the synchronization is to be carried out.
- Correction factor
 - Lose or gain in the clock time may be compensated within a 24 hour period by means of the correction factor in ms.
 - If the clock is 1s slow after 24 hours, you have to specify a correction factor of "+1000" ms.

Protection

- Level of protection
 - Here 1 of 3 protection levels may be set to protect the CPU from unauthorized access.
 - *Protection level 1 (default setting):*
No password adjustable, no restrictions
 - *Protection level 2 with password:*
Authorized users: read and write access
Unauthorized user: read access only
 - *Protection level 3:*
Authorized users: read and write access
Unauthorized user: no read and write access

4.8.3 Parameter for MPI/DP

The properties dialog of the MPI(PtP) interface X3 is opened via a double click to the sub module MPI/DP



To switch the interface X3 MPI(PtP) to PROFIBUS functionality you have to activate the according bus functionality by means of a VSC storage media from VIPA. By plugging the VSC storage card and then an overall reset the according functionality is activated. ↪ 'Deployment storage media - VSD, VSC' on page 85

General

- Short description
 - Here the short description "MPI/DP" for the interface is specified.
- Name
 - At *Name* "MPI/DP" is shown. If you change the name, the new name appears in the Siemens SIMATIC Manager.
- Type
 - Here you can choose between the functionalities MPI and PROFIBUS.
- Interface
 - Here the MPI respectively PROFIBUS address is shown.
- Properties
 - With this button the properties of the interface may be pre-set.
- Comment
 - You can enter the purpose of the interface.

Address

- Diagnostics
 - A diagnostics address for the interface is to be pre-set here. In the case of an error the CPU is informed via this address.
- Operating mode
 - With the interface type '*PROFIBUS*' here you can pre-set the '*Operating mode*' DP Slave.
- Configuration, Clock
 - These parameters are not supported.

4.9 Setting VIPA specific CPU parameters

Overview

Except of the VIPA specific CPU parameters the CPU parametrization takes place in the parameter dialog of the CPU 314C-2 PN/DP from Siemens. After the hardware configuration of the CPU you can set the parameters of the CPU in the virtual IO device '*VIPA SLIO CPU*'. Via double-click at the VIPA SLIO CPU the properties dialog is opened

Here the following parameters may be accessed:

- Function X3
- Additional retentive memory
- Additional retentive timer
- Additional retentive counter
- Diagnostics interrupt 5L+ (DC 24V power section supply)
- Diagnostics interrupt 2L+ (DC 24V DO power section supply)

- Diagnostics interrupt DO short circuit / overload
- Diagnostics interrupt sensor short circuit / overload
- Diagnostics interrupt 3L+ (DC 24V SLIO bus power section supply)

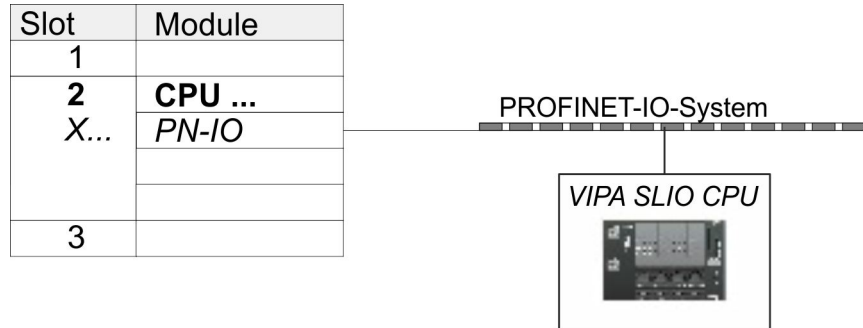

Slot	Module	Order number	
0	VIPA SLIO CPU	
X2	...		
1			
2			
3			
...			

VIPA specific parameters

The following parameters may be accessed by means of the properties dialog of the VIPA CPU.

- Function X3
 - MPI/DPS (default): In this operating mode parameters are active, which you set on sub module 'MPI/DP' of the Siemens CPU 314C-2 PN/DP. ↪ 'Option: PROFIBUS communication' on page 222
 - PTP: With this operating mode the RS485 interface acts as an interface for serial point-to-point communication. Here data may be exchanged between two stations by means of protocols. ↪ 'Deployment PtP communication' on page 198
- Additional retentive memory
 - Here enter the number of retentive memory bytes. With 0 the value 'Retentive memory → Number of memory bytes starting with MB0' is set, which is pre-set at the parameters of the Siemens CPU.
 - Range of values: 0 (default) ... 8192
- Additional retentive timer
 - Enter the number of S7 timers. With 0 the value 'Retentive memory → Number S7 timers starting with T0' is set, which is pre-set at the parameters of the Siemens CPU.
 - Range of values: 0 (default) ... 512

- Additional retentive counter
 - Enter the number of S7 counter. With 0 the value 'Retentive memory → Number S7 counters starting with C0' is set, which is pre-set at the parameters of the Siemens CPU.
 - Range of values: 0 (default) ... 512
- Diagnostics interrupt (default: deactivated)
 - Error: 5L+ (DC 24V DI power section supply)
 - Error: 2L+ (DC 24V DO power section supply)
 - Error: 3L+ (DC 24V SLIO bus power section supply)
 - Short circuit / overload: DO
 - Short circuit / overload: Sensor

4.10 Project transfer

Overview

There are the following possibilities for project transfer into the CPU:

- Transfer via MPI
- Transfer via Ethernet
- Transfer via memory card



To switch the interface X3 MPI(PtP) to PROFIBUS functionality you have to activate the according bus functionality by means of a VSC storage media from VIPA. By plugging the VSC storage card and then an overall reset the according functionality is activated. ↪ 'Deployment storage media - VSD, VSC' on page 85

4.10.1 Transfer via MPI

General

For transfer via Ethernet the CPU has the following interface:

- X3: MPI(PtP) ↪ 'X3: MPI(PtP) interface' on page 40

Net structure

The structure of a MPI net is electrically identical with the structure of a PROFIBUS net. This means the same rules are valid and you use the same components for the build-up. The single participants are connected with each other via bus interface plugs and PROFIBUS cables. Per default the MPI net runs with 187.5kbaud. VIPA CPUs are delivered with MPI address 2.

MPI programming cable

The MPI programming cables are available at VIPA in different variants. The cables provide a RS232 res. USB plug for the PC and a bus enabled RS485 plug for the CPU. Due to the RS485 connection you may plug the MPI programming cables directly to an already plugged plug on the RS485 jack. Every bus participant identifies itself at the bus with an unique address, in the course of the address 0 is reserved for programming devices.

Terminating resistor

A cable has to be terminated with its surge impedance. For this you switch on the terminating resistor at the first and the last participant of a network or a segment. Please make sure that the participants with the activated terminating resistors are always power supplied. Otherwise it may cause interferences on the bus.

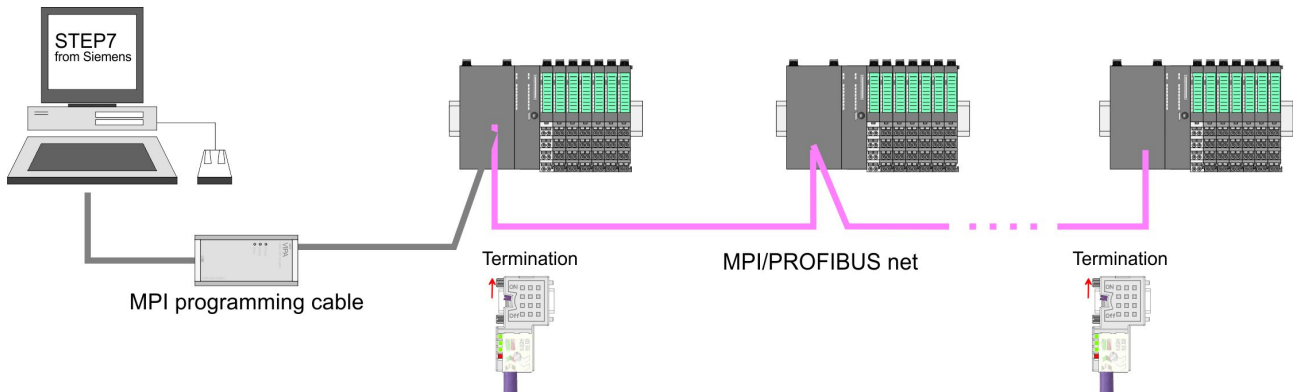

Approach transfer via MPI interface

1. ▶ Connect your PC to the MPI jack of your CPU via a MPI programming cable.
2. ▶ Load your project in the SIMATIC Manager from Siemens.
3. ▶ Choose in the menu *'Options → Set PG/PC interface'*.
4. ▶ Select in the according list the "PC Adapter (MPI)"; if appropriate you have to add it first, then click on [Properties].
5. ▶ Set in the register MPI the transfer parameters of your MPI net and type a valid address.
6. ▶ Switch to the register *Local connection*.
7. ▶ Set the COM port of the PCs and the transfer rate 38400baud for the MPI programming cable from VIPA.
8. ▶ Transfer your project via *'PLC → Load to module'* via MPI to the CPU and save it with *'PLC → Copy RAM to ROM'* on a memory card if one is plugged.

4.10.2 Transfer via Ethernet

For transfer via Ethernet the CPU has an Ethernet PG/OP channel. For online access to this, you have to assign IP address parameters to this by means of "initialization" and transfer them into your project. For transfer connect, if not already done, one of the Ethernet jack (X1, X2) of the Ethernet PG/OP channel to Ethernet, to which your programming device (PC) is connected. The connection happens via an integrated 2-port switch (X1, X2) For transfer via Ethernet the CPU has the following interface:

- X1/X2: Ethernet PG/OP channel via an integrated 2-port switch

Initialization

So that you may access the Ethernet PG/OP channel you have to assign IP address parameters by means of the "initialization".
 ↪ *'Hardware configuration - Ethernet PG/OP channel'* on page 64

Transfer

1. ▶ For the transfer, connect, if not already done, the appropriate Ethernet port to your Ethernet.
2. ▶ Open your project with the Siemens SIMATIC Manager.
3. ▶ Set via *'Options → Set PG/PC Interface'* the access path to "TCP/IP → Network card".

4. ▶ Click to 'PLC → Download' Download → the dialog "Select target module" is opened. Select your target module and enter the IP address parameters of the Ethernet PG/OP channel for connection. Provided that no new hardware configuration is transferred to the CPU, the entered Ethernet connection is permanently stored in the project as transfer channel.
5. ▶ With [OK] the transfer is started.



System dependent you get a message that the projected system differs from target system. This message may be accepted by [OK].

→ Your project is transferred and may be executed in the CPU after transfer.

4.10.3 Transfer via memory card

The memory serves as external transfer and storage medium. There may be stored several projects and sub-directories on a memory card. Please regard that your current project is stored in the root directory and has one of the following file names:

- S7PROG.WLD
- AUTOLOAD.WLD

With 'File → Memory Card File → New' in the Siemens SIMATIC Manager a new wld file may be created. After the creation copy the blocks from the project blocks folder and the *System data* into the wld file.

Transfer memory card → CPU

The transfer of the application program from the memory card into the CPU takes place depending on the file name after an overall reset or PowerON.

- *S7PROG.WLD* is read from the memory card after overall reset.
- *AUTOLOAD.WLD* is read from the memory card after PowerON.

A short lightning up of the SD LED of the CPU marks the active transfer. Please regard that your user memory serves for enough space for your user program, otherwise your user program is not completely loaded and the SF LED gets on.

Transfer CPU → memory card

When a memory card has been installed, the write command stores the content of the RAM as *S7PROG.WLD* on the memory card.

The write command is controlled by means of the block area of the Siemens SIMATIC Manager 'PLC → Copy RAM to ROM'. The SD LED lights up during the write access. When the LED expires, the write process is finished.

If this project is to be loaded automatically from the memory card with PowerON, you have to rename this to on the memory card to *AUTOLOAD.WLD*.

Checking the transfer operation

After accessing the memory card you can find a diagnostics entry in the CPU. To monitor the diagnostics entries you choose in the Siemens SIMATIC manager 'PLC → Module information'. Via the register "Diagnostic Buffer" you reach the diagnostic window. ↪ 'Diagnostic entries' on page 92

4.11 Accessing the web server

4.11.1 Access via the Ethernet PG/OP channel



There is a web server, which can be accessed via the IP address of the Ethernet PG/OP channel with an Internet browser. At the web page information about the CPU and its connected modules can be found. ↪ 'Hardware configuration - Ethernet PG/OP channel' on page 64

It is assumed that there is a connection between PC and CPU with Internet browser via the Ethernet PG/OP channel. This may be tested by Ping to the IP address of the Ethernet PG/OP channel.

4.11.2 Structure of the web page

The web page is built dynamically and depends on the number of modules, which are connected to the CPU. The web page only shows information. The shown values cannot be changed



Please consider the System SLIO power and clamp modules do not have any module ID. These may not be recognized by the CPU and so are not listed and considered during slot allocation.

4.11.3 Web page with selected CPU

VIPA

- Device (VIPA 013-CCF0R00) ←
- Module 1 (VIPA 0.....)
- Module 2 (VIPA 0.....)
- ...

Name	Value
Ordering Info	013-CCF0R00
Serial	00108765
Version	01V08.001
HW Revision	01
Software	01

[Expert View ...]

Info - Overview

Here order number, serial number and the version of firmware and hardware of the CPU are listed. [Expert View] takes you to the advanced "Expert View".

Accessing the web server > Web page with selected CPU

Info - Expert View

Runtime Information		
Operation Mode	RUN	CPU: Status information
Mode Switch	RUNP	
System Time	03.11.15 14:32:49:561	CPU: Date, time
OB1-Cycle Time	cur = 2000us, min = 2000us, max = 5000us, avg = 2335us	CPU: Cyclic time: min = minimum cur = current max = maximum avg = average
Interface Information		
X1	PG/OP Ethernet Port 1	Operating mode of the interfaces
X2	PG/OP Ethernet Port 2	
X3	MPI (default) PtP	
X4	DI 16 Counter AI2	Information about the input part
X5	DO 12 Counter	Information about the output part
VIPASetCard Info		
VSD...		Activated VSD respectively VSC with Information for the support
...		
VSC...		
...		
VSC-Trial-Time	71:59	Remaining time in hh:mm for deactivation of the expansion memory respectively bus functionality and the CPU goes to STOP (abnormal operation), if the VSC is removed. This parameter is only visible when the VSC of an enabled function is removed.
Memory Extension	0 bytes	Size of the additional memory, which was activated by means of a VSC.

Accessing the web server > Web page with selected CPU

PROFIBUS	not activated	Type of the PROFIBUS functionality, which was activated by means of a VSC.
Memory Usage		
LoadMem	118368/524288 bytes	CPU: Information to memory configuration
WorkMemCode	42656/262144 bytes	Load memory, working memory (code/data)
WorkMemData	33204/262144 bytes	
PG/OP Network Information		
Device Name	PLC_01	Ethernet PG/OP channel:
IP Address	192.168.10.124	Address information
Subnet Mask	255.255.255.0	
Gateway Address	192.168.10.124	
MAC Address	00:20:D5:02:05:4A	
Network Information Port X1		
Link Mode	100 Mbps - Full Duplex	Link mode of the interfaces
Network Information Port X2		
Link Mode	100 Mbps - Full Duplex	
CPU Firmware Information		
File System	V1.0.2	CPU: Information for the support
PRODUCT	VIPA 013-CCF0R00 V1.4.2.0 Px000265.pkg SVN_REV = 39784, BUILD_ID = 2015-07-23_17-40-41, USER = SWBuildServer	CPU: Name, firmware version, package
HARDWARE	V0.1.0.0 5841G-V11 MX000303.003	CPU: Information for the support
Bx000501	V1.4.2.0	
Ax000136	V1.0.4.0	

Accessing the web server > Web page with selected module

fx000018.wld	V1.0.1.0	
syslibex.wld	n/a	
Protect.wld	n/a	
ARM Processor Load		
Measurement Cycle Time	10ms	
Last Value	29%	
Maximum Load	32%	

Data Currently nothing is displayed here.

Parameter Currently nothing is displayed here.

IP Here the IP address data of your Ethernet PG/OP channel are shown.

4.11.4 Web page with selected module

The screenshot shows the VIPA web interface. On the left, there is a navigation menu with the following items: Device (VIPA 01.....), Module 1 (VIPA 021-1BD00), Module 2 (VIPA), and ... A red arrow points from the 'Module 1 (VIPA 021-1BD00)' entry to the 'Info' tab of the table on the right. The table is titled 'Module 1 (VIPA 021-1BD00) information' and has three tabs: Info, Data, and Parameter. The 'Info' tab is active and contains the following data:

Name	Value
Ordering Info	021-1BD00
Serial	00103265
Version	01V30.001
HW Revision	01

Info Here product name, order number, serial number, firmware version and hardware state number of the according module are listed.

Data Here the address and the state of the inputs respectively outputs are listed.

Parameter With parameterizable modules e.g. analog modules the parameter setting is shown here. These come from the hardware configuration.

4.12 Operating modes

4.12.1 Overview

The CPU can be in one of 3 operating modes:

- Operating mode STOP
- Operating mode START-UP
(OB 100 - restart / OB 102 - cold start *)
- Operating mode RUN

Certain conditions in the operating modes START-UP and RUN require a specific reaction from the system program. In this case the application interface is often provided by a call to an organization block that was included specifically for this event.

Operating mode STOP

- The application program is not processed.
- If there has been a processing before, the values of counters, timers, flags and the process image are retained during the transition to the STOP mode.
- Command output disable (BASP) is activated this means the all digital outputs are disabled.
- RUN-LED off
- STOP-LED on

Operating mode START-UP

- During the transition from STOP to RUN a call is issued to the start-up organization block OB 100.
 - The processing time for this OB is not monitored.
 - The START-UP OB may issue calls to other blocks.
- All digital outputs are disabled during the START-UP, this means BASP is activated.
- RUN LED
 - The RUN LED blinks as soon as the OB 100 is operated and for at least 3s, even if the start-up time is shorter or the CPU gets to STOP due to an error.
 - This indicates the start-up.
- STOP LED
 - During the processing of the OB 100 the STOP LED is on and then turns off.
- When the CPU has completed the START-UP OB, it assumes the operating mode RUN.



* OB 102 (Cold start)

If there is a "Watchdog" error the CPU still remains in STOP state. With such an error the CPU must be manually started again. For this the OB 102 (cold start) must exist. The CPU will not go to RUN without the OB 102. Alternatively you can bring your CPU in RUN state again by an overall reset respectively by reloading your project.

Please consider that the OB 102 (cold start) may exclusively be used for treatment of a watchdog error.

- Operating mode RUN**
- The application program in OB 1 is processed in a cycle. Under the control of alarms other program sections can be included in the cycle.
 - All timers and counters being started by the program are active and the process image is updated with every cycle.
 - BASP is deactivated, i.e. all outputs are enabled.
 - RUN-LED on
 - STOP-LED off

4.12.2 Function security

The CPUs include security mechanisms like a Watchdog (100ms) and a parameterizable cycle time surveillance (parameterizable min. 1ms) that stop res. execute a RESET at the CPU in case of an error and set it into a defined STOP state. The VIPA CPUs are developed function secure and have the following system properties:

Event	concerns	Effect
RUN → STOP	general	BASP (B efehls- A usgabe- S perre, i.e. command output lock) is set.
	central digital outputs	The outputs are disabled.
	central analog outputs	The outputs are disabled. <ul style="list-style-type: none"> ■ Voltage outputs issue 0V ■ Current outputs 0...20mA issue 0mA ■ Current outputs 4...20mA issue 4mA If configured also substitute values may be issued.
	decentral outputs	Same behaviour as the central digital/analog outputs.
	decentral inputs	The inputs are cyclically be read by the decentralized station and the recent values are put at disposal.
STOP → RUN res. PowerON	general	First the PII is deleted, then OB 100 is called. After the execution of the OB, the BASP is reset and the cycle starts with: Delete PIO → Read PII → OB 1.
	decentral inputs	The inputs are be read by the decentralized station and the recent values are put at disposal.
RUN	general	The program is cyclically executed: Read PII → OB 1 → Write PIO.

PII = Process image inputs
 PIO = Process image outputs

4.13 Overall reset

Overview

During the overall reset the entire user memory is erased. Data located in the memory card is not affected. You have 2 options to initiate an overall reset:

- Overall reset by means of the operating mode switch
- Overall reset by means of the Siemens SIMATIC Manager



You should always establish an overall reset to your CPU before loading an application program into your CPU to ensure that all blocks have been cleared from the CPU.

4.13.1 Overall reset by means of the operating mode switch

Proceeding

1. ▶ Your CPU must be in STOP mode. For this switch the operating mode switch of the CPU to STOP.
 - ⇒ The STOP-LED is on.
2. ▶ Switch the operating mode switch to MR position for about 3 seconds.
 - ⇒ The STOP-LED blinks and changes from repeated blinking to permanently on.
3. ▶ Place the operating mode switch in the position STOP and switch it to MR and quickly back to STOP within a period of less than 3 seconds.
 - ⇒ The STOP-LED blinks fast (overall reset procedure).
4. ▶ The overall reset has been completed when the STOP-LED is on permanently.
 - ⇒ The STOP-LED is on.

The following figure illustrates the above procedure:

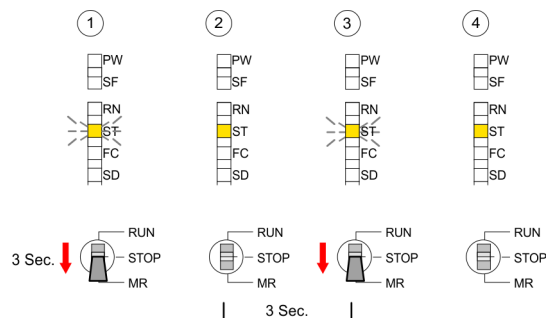

4.13.2 Overall reset by means of the Siemens SIMATIC Manager

Proceeding

For the following proceeding you must be online connected to your CPU.

1. ▶ For an overall reset the CPU must be switched to STOP state. You may place the CPU in STOP by the menu command 'PLC → Operating mode'.
2. ▶ You may request the overall reset by means of the menu command 'PLC → Clean/Reset'.
 - ⇒ A dialog window opens. Here you can bring your CPU in STOP state, if not already done, and start the overall reset. During the overall reset procedure the STOP-LED flashes. When the STOP-LED is on permanently the overall reset procedure has been completed.

4.13.3 Actions after a memory reset

Activating functionality by means of a VSC

If there is a VSC from VIPA plugged, after an overall reset the according functionality is automatically activated. ↪ 'VSD' on page 86

Automatic reload

If there is a project S7PROG.WLD on the memory card, after an overall reset the CPU attempts to reload this project from the memory card. → The SD LED is on. When the reload has been completed the LED expires. The operating mode of the CPU will be STOP respectively RUN, depending on the position of the operating mode switch.

Reset to factory setting

The *Reset to factory setting* deletes completely the internal RAM of the CPU and resets this to delivery state. Please regard that the MPI address is also set back to default 2! ↪ 'Reset to factory settings' on page 84

4.14 Firmware update

Overview

There is the opportunity to execute a firmware update for the CPU and its components via memory card. For this an accordingly prepared memory card must be in the CPU during the start-up. So a firmware files can be recognized and assigned with start-up, a pkg file name is reserved for each update-able component and hardware release, which begins with "px" and differs in a number with 6 digits. The pkg file name of every update-able component can be found at a label on the module. The SLIO CPU has no label. Here the pkg file name can be shown via the web page. After PowerON and operating mode switch in STOP position, the CPU checks if there is a *.pkg file at the memory card. If this firmware version is different to the existing firmware version, this is indicated by blinking of the LEDs and the firmware may be installed by an update request.

Current firmware at www.vipa.com

The latest firmware versions can be found in the "service" area at www.vipa.com. For example the following files are necessary for the firmware update of the CPU and its components with hardware release 1:

- CPU 013C, Hardware release 1: Px000265.pkg

**CAUTION!**

When installing a new firmware you have to be extremely careful. Under certain circumstances you may destroy the CPU, for example if the voltage supply is interrupted during transfer or if the firmware file is defective. In this case, please call the VIPA Hotline!

Please regard that the version of the update firmware has to be different from the existing firmware otherwise no update is executed.

Display the firmware version via web page

The CPU has an integrated web page that monitors information about the firmware version of the SPEED7 components. The Ethernet PG/OP channel provides the access to this web page. To activate the PG/OP channel you have to enter according IP parameters. This happens either by a hardware configuration, loaded by memory card respectively MPI or via Ethernet by means of the MAC address with 'PLC → Assign Ethernet Address'. After that you may access the PG/OP channel with a web browser via the set IP address. ↪ 'Hardware configuration - Ethernet PG/OP channel' on page 64

Load firmware and transfer it to memory card

1. ▶ Go to www.vipa.com
2. ▶ Click 'Service Support → Downloads → Firmware'.
3. ▶ Via 'System SLIO → CPU' navigate to your CPU and download the zip file to your PC.
4. ▶ Unzip the zip file and copy the pgk file to the root directory of your memory card.

**CAUTION!**

With a firmware update an overall reset is automatically executed. If your program is only available in the load memory of the CPU it is deleted! Save your program before executing a firmware update! After a firmware update you should execute a "Reset to factory setting".
↪ 'Reset to factory settings' on page 84

Transfer firmware from memory card into CPU



Please note that with some firmware versions an additional firmware update via alternate blinking of the LEDs SF and FC can be indicated even when the operating mode switch is in RUN position. In this state the CPU can only restart, if you establish a further firmware update process. For this tap the operating mode switch shortly downwards to MR and follow the procedures described below.

1. Switch the operating mode switch of your CPU in position STOP. Turn off the power supply. Plug the memory card with the firmware files into the CPU. Please take care of the correct plug-in direction of the memory card. Turn on the power supply.
2. After a short boot-up time, the alternate blinking of the LEDs SF and FC shows that at least a more current firmware file was found at the memory card.
3. You start the transfer of the firmware as soon as you tip the operating mode switch downwards to MR within 10s and then leave the switch in STOP position.
4. During the update process, the LEDs SF and FC are alternately blinking and SD LED is on. This may last several minutes.
5. The update is successful finished when the LEDs PW, ST, SF, FC and SD are on. If they are blinking fast, an error occurred.
6. Turn power OFF and ON. Now it is checked by the CPU, whether further firmware updates are to be executed. If so, again the LEDs SF and FC flash after a short start-up period. Continue with 3. If the LEDs do not flash, the firmware update is finished.
7. Now a *Reset to factory setting* as described next should be executed. After that the CPU is ready for duty. ↪ Chapter 4.15 'Reset to factory settings' on page 84

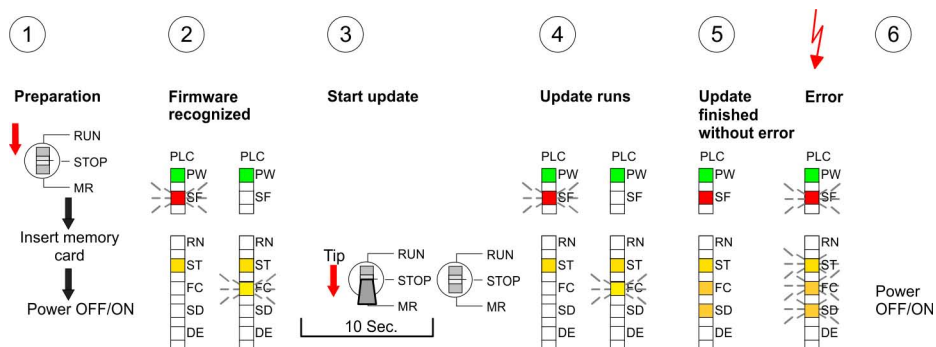

4.15 Reset to factory settings

Proceeding

With the following proceeding the internal RAM of the CPU is completely deleted and the CPU is reset to delivery state.

Please regard that the MPI address is also reset to default 2 and the IP address of the Ethernet PG/OP channel is reset to 0.0.0.0!

A factory reset may also be executed by the command `FAC-TORY_RESET`. ↪ *'CMD - auto commands' on page 89*

1. ➤ Switch the CPU to STOP.
2. ➤ Push the operating mode switch down to position MR for 30 seconds. Here the STOP-LED flashes. After a few seconds the STOP LED changes to static light. Now the STOP LED changes between static light and flashing. Start here to count the static light of the STOP LED.
3. ➤ After the 6. static light release the operating mode switch and tip it downwards to MR. Now the RUN LED lights up once. This means that the RAM was deleted completely.
4. ➤ For the confirmation of the resetting procedure the LEDs PW, ST, SF, FC and MC get on. If not, the factory reset has failed and only an overall reset was executed. In this case you can repeat the procedure. A factory reset can only be executed if the STOP LED has static light for exact 6 times.
5. ➤ The end of factory reset is shown by static light of the LEDs PW, ST, SF, FC and SD. Switch the power supply off and on.

The following figure illustrates the procedure above:

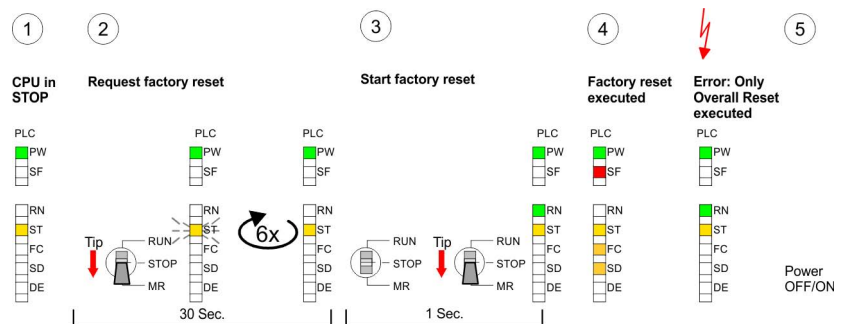

After a firmware update of the CPU you always should execute a Factory reset.

4.16 Deployment storage media - VSD, VSC

Overview

At the front of the CPU there is a slot for storage media. Here the following storage media can be plugged:

- VSD - VIPA **SD-Card**
 - External memory card for programs and firmware.
- VSC - VIPA**SetCard**
 - External memory card (VSD) for programs and firmware with the possibility to unlock optional functions like work memory and field bus interfaces.
 - These functions can be purchased separately.
 - To activate the corresponding card is to be installed and a *Overall reset* is to be established. ↪ *'Overall reset' on page 81*



A list of the currently available VSD respectively VSC can be found at www.vipa.com

You can cause the CPU to load a project automatically respectively to execute a command file by means of pre-defined file names.

VSD

VSDs are external storage media based on SD memory cards. VSDs are pre-formatted with the PC format FAT 16 (max. 2GB) and can be accessed via a card reader. After PowerON respectively an overall reset the CPU checks, if there is a VSD with data valid for the CPU.

Push the VSD into the slot until it snaps in leaded by a spring mechanism. This ensures contacting. By sliding down the sliding mechanism, a just installed VSD card can be protected against drop out.

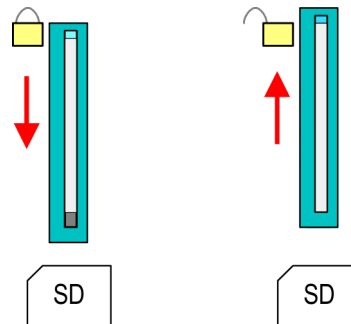

To remove, slide the sliding mechanism up again and push the storage media against the spring pressure until it is unlocked with a click.



CAUTION!

If the media was already unlocked by the spring mechanism, with shifting the sliding mechanism, a just installed memory card can jump out of the slot!

VSC

The VSC is a VSD with the possibility to enable optional functions. Here you have the opportunity to accordingly expand your work memory respectively enable field bus functions. Information about the enabled functions can be shown via the web page. ↪ 'Accessing the web server' on page 75

**CAUTION!**

Please regard that the VSC must remain plugged when you've enabled optional functions at your CPU. Otherwise the SF LED is on and the CPU switches to STOP after 72 hours. As soon as an activated VSC is not plugged, the SF LED is on and the "TrialTime" counts downwards from 72 hours to 0. After 72 hours the CPU switches to STOP state. By plugging the VSC, the SF LED expires and the CPU is running again without any restrictions.

The VSC cannot be replaced by a VSC of the same optional functions. The activation code is fixed to the VSD by means of an unique serial number. Here the function as an external memory card is not affected.

Accessing the storage medium

To the following times an access takes place on a storage medium:

After overall reset

- The CPU checks if a VSC is inserted. If so, the corresponding optional functions are enabled.
- The CPU checks whether a project S7PROG.WLD exists. If so, it is automatically loaded.

After PowerON

- The CPU checks whether a project AUTOLOAD.WLD exists. If so, an overall reset is executed and the project is automatically loaded.
- The CPU checks whether a command file with the name VIPA_CMD.MMC exists. If so the command file is loaded and the commands are executed.
- After PowerON and CPU STOP the CPU checks if there is a *.pkg file (firmware file). If so, this is shown by the CPU by blinking LEDs and the firmware may be installed by an update request.
 *'Firmware update' on page 82*

Once in STOP state

- If a memory card is plugged, which contains a command file VIPA_CMD.MMC, the command file is loaded and the containing instructions are executed.



The FC/SFC 208 ... FC/SFC 215 and FC/SFC 195 allow you to include the memory card access into your user application. More can be found in the manual operation list (HB00_OPL_SP7) of your CPU.

4.17 Extended know-how protection**Overview**

Besides the "standard" Know-how protection the SPEED7-CPU's from VIPA provide an "extended" know-how protection that serves a secure block protection for accesses of 3. persons.

Standard protection

The standard protection from Siemens transfers also protected blocks to the PG but their content is not displayed. But with according manipulation the Know-how protection is not guaranteed.

Extended protection

The "extended" know-how protection developed by VIPA offers the opportunity to store blocks permanently in the CPU. With the "extended" protection you transfer the protected blocks to a memory card into a WLD-file named protect.wld. By plugging the memory card and then an overall reset the blocks in the protect.wld are permanently stored in the CPU. You may protect OBs, FBs and FCs. When back-reading the protected blocks into the PG, exclusively the block header are loaded. The block code that is to be protected remains in the CPU and cannot be read.

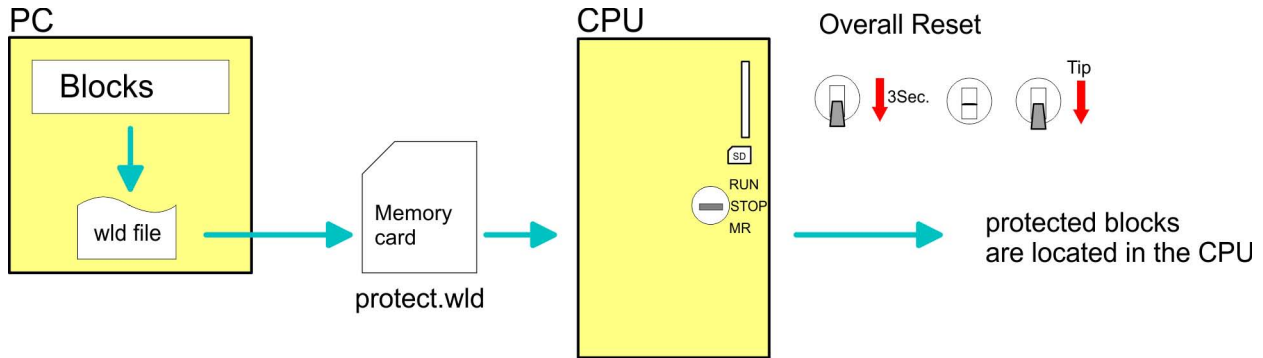

Protect blocks with protect.wld

Create a new wld-file in your project engineering tool with 'File → Memory Card file → New' and rename it to "protect.wld". Transfer the according blocks into the file by dragging them with the mouse from the project to the file window of protect.wld.

Transfer protect.wld to CPU with overall reset

Transfer the file protect.wld to a memory card, plug the memory card into the CPU and execute an overall reset with the following approach:

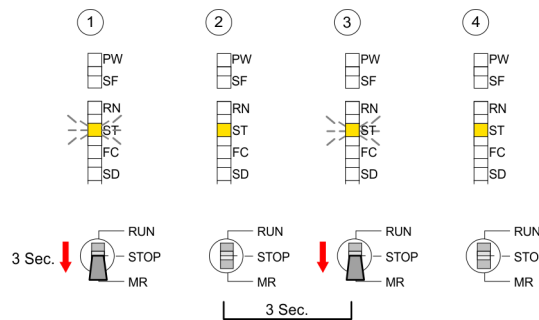

The overall reset stores the blocks in protect.wld permanently in the CPU protected from accesses of 3. persons.

Protection behaviour

Protected blocks are overwritten by a new protect.wld. Using a PG 3. persons may access protected blocks but only the block header is transferred to the PG. The block code that is to be protected remains in the CPU and cannot be read.

Change respectively delete protected blocks

Protected blocks in the RAM of the CPU may be substituted at any time by blocks with the same name. This change remains up to next overall reset. Protected blocks may permanently be overwritten only if these are deleted at the protect.wld before. A factory reset does not affect the protected blocks. By transferring an empty protect.wld from the memory card with an overall reset, you may delete all protected blocks in the CPU.

Usage of protected blocks

Due to the fact that reading of a "protected" block from the CPU monitors no symbol labels it is convenient to provide the "block covers" for the end user. For this, create a project of all protected blocks. Delete all networks in the blocks so that these only contain the variable definitions in the according symbolism.

4.18 CMD - auto commands

Overview

A *Command* file at a memory card is automatically executed under the following conditions:

- CPU is in STOP and memory card is plugged
- After each PowerON

Command file

The *Command* file is a text file, which consists of a command sequence to be stored as **vipa_cmd.mmc** in the root directory of the memory card. The file has to be started by `CMD_START` as 1. command, followed by the desired commands (no other text) and must be finished by `CMD_END` as last command.

Text after the last command `CMD_END` e.g. comments is permissible, because this is ignored. As soon as the command file is recognized and executed each action is stored at the memory card in the log file logfile.txt. In addition for each executed command a diagnostics entry may be found in the diagnostics buffer.

Commands

Please regard the command sequence is to be started with `CMD_START` and ended with `CMD_END`.

Command	Description	Diagnostics entry
CMD_START	In the first line CMD_START is to be located.	0xE801
	There is a diagnostics entry if CMD_START is missing.	0xE8FE
WAIT1SECOND	Waits about 1 second.	0xE803
LOAD_PROJECT	The function "Overall reset and reload from memory card" is executed. The wld file located after the command is loaded else "s7prog.wld" is loaded.	0xE805
SAVE_PROJECT	The recent project (blocks and hardware configuration) is stored as "s7prog.wld" at the memory card. If the file just exists it is renamed to "s7prog.old". If your CPU is password protected so you have to add this as parameter. Otherwise there is no project written. Example: SAVE_PROJECT password	0xE806
FACTORY_RESET	Executes "factory reset".	0xE807
DIAGBUF	The current diagnostics buffer of the CPU is stored as "diagbuff.txt" at the memory card.	0xE80B

Command	Description	Diagnostics entry
SET_NETWORK	IP parameters for Ethernet PG/OP channel may be set by means of this command. The IP parameters are to be given in the order IP address, subnet mask and gateway in the format x.x.x.x each separated by a comma. Enter the IP address if there is no gateway used.	0xE80E
CMD_END	In the last line CMD_END is to be located.	0xE802

Examples

The structure of a command file is shown in the following. The corresponding diagnostics entry is put in parentheses.

Example 1

CMD_START	Marks the start of the command sequence (0xE801)
LOAD_PROJECT proj.wld	Execute an overall reset and load "proj.wld" (0xE805)
WAIT1SECOND	Wait ca. 1s (0xE803)
DIAGBUF	Store diagnostics buffer of the CPU as "diagbuff.txt" (0xE80B)
CMD_END	Marks the end of the command sequence (0xE802)
... arbitrary text ...	Text after the command CMD_END is not evaluated.

Example 2

CMD_START	Marks the start of the command sequence (0xE801)
LOAD_PROJECT proj2.wld	Execute an overall reset and load "proj2.wld" (0xE805)
WAIT1SECOND	Wait ca. 1s (0xE803)
WAIT1SECOND	Wait ca. 1s (0xE803)
	IP parameter (0xE80E)
SET_NETWORK 172.16.129.210,255.255.224.0,172.16.129.210	
WAIT1SECOND	Wait ca. 1s (0xE803)
WAIT1SECOND	Wait ca. 1s (0xE803)
DIAGBUF	Store diagnostics buffer of the CPU as "diagbuff.txt" (0xE80B)
CMD_END	Marks the end of the command sequence (0xE802)
... arbitrary text ...	Text after the command CMD_END is not evaluated.



The parameters IP address, subnet mask and gateway may be received from the system administrator. Enter the IP address if there is no gateway used.

4.19 Control and monitoring of variables with test functions

Overview

- For troubleshooting purposes and to display the status of certain variables you can access certain test functions via the menu item **Debug** of the Siemens SIMATIC Manager.
- The status of the operands and the RLO can be displayed by means of the test function '*Debug → Monitor*'.
- The status of the operands and the RLO can be displayed by means of the test function '*PLC → Monitor/Modify Variables*'.

'Debug → Monitor'

- This test function displays the current status and the RLO of the different operands while the program is being executed.
- It is also possible to enter corrections to the program.
- The processing of the states may be interrupted by means of jump commands or by timer and process-related interrupts.
- At the breakpoint the CPU stops collecting data for the status display and instead of the required data it only provides the PG with data containing the value 0.
- The interruption of the processing of statuses does not change the execution of the program. It only shows that the data displayed is no longer valid.



When using the test function "Monitor" the PLC must be in RUN mode!

For this reason, jumps or time and process alarms can result in the value displayed during program execution remaining at 0 for the items below:

- the result of the logical operation RLO
- Status / AKKU 1
- AKKU 2
- Condition byte
- absolute memory address SAZ. In this case SAZ is followed by a "?".

**'PLC
→ Monitor/Modify
Variables'**

This test function returns the condition of a selected operand (inputs, outputs, flags, data word, counters or timers) at the end of program execution. This information is obtained from the corresponding area of the selected operands. During the controlling of variables respectively in operating mode STOP the input area is directly read. Otherwise only the process image of the selected operands is displayed.

- Control of outputs
 - Serves to check the wiring and proper operation of output modules.
 - If the CPU is in RUN mode, so only outputs can be controlled, which are not controlled by the user program. Otherwise values would be instantly overwritten.
 - If the CPU is in STOP - even without user program, so you need to disable the command output lock BASP ('Enable PO'). Then you can control the outputs arbitrarily
- Controlling variables
 - The following variables may be modified: I, Q, M, T, C and D.
 - The process image of binary and digital operands is modified independently of the operating mode of the CPU.
 - When the operating mode is RUN the program is executed with the modified process variable. When the program continues they may, however, be modified again without notification.
- Forcing variables
 - You can pre-set individual variables of a user program with fixed values so that they can not be changed or overwritten by the user program of the CPU.
 - By pre-setting of variables with fixed values, you can set certain situations for your user program and thus test the programmed functions.



CAUTION!

Please consider that controlling of output values represents a potentially dangerous condition.

Even after a power cycle forced variables remain forced with its value, until the force function is disabled.

These functions should only be used for test purposes respectively for troubleshooting. More information about the usage of these functions may be found in the manual of your configuration tool.

4.20 Diagnostic entries

Accessing diagnostic data

- You may read the diagnostics buffer of the CPU via the Siemens SIMATIC Manager. Besides of the standard entries in the diagnostics buffer, the VIPA CPUs support some additional specific entries as Event-IDs.
- To monitor the diagnostics entries you choose in the Siemens SIMATIC manager 'PLC → Module information'. Via the register "Diagnostics Buffer" you reach the diagnostics window.
- The current content of the diagnostic buffer is stored at the memory card by means of the CMD DIAGBUF. ↪ 'CMD - auto commands' on page 89
- The diagnostic is independent from the operating mode of the CPU. You may store a max. of 100 diagnostic entries in the CPU.

Overview of event IDs

Event-ID	Meaning
0x115C	Vendor-specific interrupt (OB 57) at EtherCAT
	OB: OB number
	ZInfo1: Logical address of the slave that triggered the interrupt
	ZInfo2: Interrupt type
	0x00: Reserved
	0x01: Diagnostic interrupt (incoming)
	0x02: Hardware interrupt
	0x03: Pull interrupt
	0x04: Plug interrupt
	0x05: Status interrupt
	0x06: Update interrupt
	0x07: Redundancy interrupt
	0x08: Controlled by the supervisor
	0x09: Enabled
	0x0A: Wrong sub module plugged
	0x0B: Restoration of the sub module
	0x0C: Diagnostic interrupt (outgoing)
	0x0D: Cross traffic connection message
	0x0E: Neighbourhood change message
	0x0F: Synchronisation message (bus)
	0x10: Synchronisation message (device)
	0x11: Network component message
	0x12: Clock synchronisation message (bus)
	0x1F: Pull interrupt module
	ZInfo3: CoE error code
0xE003	Error on accessing the periphery
	ZInfo1: Transfer type
	ZInfo2: Periphery address
	ZInfo3: Slot
0xE004	Multiple configuration of a periphery address
	ZInfo1: Periphery address
	ZInfo2: Slot
0xE005	Internal error - Please contact the VIPA Hotline!
	ZInfo1: Not relevant to the user
	ZInfo2: Not relevant to the user

Diagnostic entries

Event-ID	Meaning
	ZInfo3: Not relevant to the user
0xE007	Configured in-/output bytes do not fit into periphery area
0xE008	Internal error - Please contact the VIPA Hotline!
0xE009	Error on accessing the standard backplane bus
0xE010	There is a undefined module at the backplane bus
	ZInfo2: Slot
	ZInfo3: Type ID
0xE011	Master project engineering at slave CPU not possible or wrong slave configuration
0xE012	Error at parametrization
0xE013	Error at shift register access to standard bus digital modules
0xE014	Error at Check_Sys
0xE015	Error at access to the master
	ZInfo2: Slot of the master
	ZInfo2: Page frame master
0xE016	Maximum block size at master transfer exceeded
	ZInfo1: Periphery address
	ZInfo2: Slot
0xE017	Error at access to integrated slave
0xE018	Error at mapping of the master periphery
0xE019	Error at standard back plane bus system recognition
0xE01A	Error at recognition of the operating mode (8 / 9 bit)
0xE01B	Error - maximum number of plug-in modules exceeded
0xE020	Error - interrupt information is not defined
	ZInfo2: Slot
	ZInfo3: Not relevant to the user
	DatID: Interrupt type
0xE030	Error of the standard bus
0xE033	Internal error - Please contact the VIPA Hotline!
0xE0B0	SPEED7 is not stoppable (e.g. undefined BCD value at timer)
	ZInfo1: Not relevant to the user
	ZInfo2: Not relevant to the user
	ZInfo3: Not relevant to the user
	DatID: Not relevant to the user
0xE0C0	Not enough space in work memory for storing code block (block size exceeded)
0xE0CB	Error at SSL access
	ZInfo1: Error

Event-ID	Meaning
	4: SSL wrong
	5: Sub-SSL wrong
	6: Index wrong
	ZInfo2: SSL-ID
	ZInfo3: Index
0xE0CC	Communication error MPI/serial
	ZInfo1: Error code
	1: Wrong priority
	2: Buffer overflow
	3: Telegram format error
	4: Wrong SSL request (SSL-ID not valid)
	5: Wrong SSL request (SSL-Sub-ID invalid)
	6: Wrong SSL request (SSL-Index not valid)
	7: Wrong value
	8: Wrong return value
	9: Wrong SAP
	10: Wrong connection type
	11: Wrong sequence number
	12: Faulty block number in the telegram
	13: Faulty block type in the telegram
	14: Inactive function
	15: Wrong size in the telegram
	20: Error in writing on MMC
	90: Faulty buffer size
	98: Unknown error
	99: Internal error
0xE0CD	Error at DP-V1 job management
	ZInfo1: Not relevant to the user
	ZInfo2: Not relevant to the user
	ZInfo3: Not relevant to the user
	DatID: Not relevant to the user
0xE0CE	Error: Timeout at sending of the I-slave diagnostics
0xE100	Memory card access error
0xE101	Memory card error file system
0xE102	Memory card error FAT
0xE104	Memory card error at saving

Diagnostic entries

Event-ID	Meaning
	ZInfo3: Not relevant to the user
0xE200	Memory card writing finished (Copy Ram2Rom)
	PK: Not relevant to the user
	OB: Not relevant to the user
0xE210	Memory card reading finished (reload after overall reset)
	ZInfo1: Not relevant to the user
	PK: Not relevant to the user
	OB: Not relevant to the user
0xE21E	Memory card reading: Error at reload (after overall reset), file "Protect.wld" too big
	OB: Not relevant to the user
0xE21F	Memory card reading: Error at reload (after overall reset), file read error, out of memory
	PK: Not relevant to the user
	OB: Not relevant to the user
	ZInfo1: Not relevant to the user
	ZInfo2: BstTyp
	0x38: OB
	0x45: FB
	0x43: FC
	0x41: DB
	0x42: SDB
	0x44: SFC
	0x46: SFB
	ZInfo3: BstNr
0xE300	Internal flash writing finished (Copy Ram2Rom)
0xE310	Internal flash writing finished (reload after battery failure)
0xE400	FSC card was plugged
	DatID: FeatureSet Trialtime in minutes
	ZInfo1: Memory extension in kB
	ZInfo2: FeatureSet PROFIBUS
	ZInfo2: FeatureSet field bus
	ZInfo2: FeatureSet motion
	ZInfo2: Reserved
0xE401	FSC card was removed
	DatID: FeatureSet Trialtime in minutes
	ZInfo1: Memory extension in kB
	ZInfo2: FeatureSet PROFIBUS

Event-ID	Meaning
	ZInfo2: FeatureSet field bus
	ZInfo2: FeatureSet motion
	ZInfo2: Reserved
0xE402	A configured functionality is not activated
	ZInfo1: FCS ErrorCode
	1: The PROFIBUS functionality is disabled The interface acts further as MPI interface
	2: The EtherCAT functionality is not enabled
	3: The number of configured axis is not enabled
0xE403	FSC can not be activated in this CPU
	ZInfo1: Memory extension in kB
	ZInfo2: FeatureSet PROFIBUS
	ZInfo2: FeatureSet field bus
	ZInfo2: FeatureSet motion
	ZInfo2: Reserved
0xE404	FeatureSet deleted due to CRC error
	DatID: Not relevant to the user
0xE405	The trial time of a feature set or MMC has expired
	DatID: Not relevant to the user
0xE410	A CPU feature set was activated
	DatID: Not relevant to the user
0xE500	Memory management: Deleted block without corresponding entry in BstList
	ZInfo2: Block type
	0x38: OB
	0x45: FB
	0x43: FC
	0x41: DB
	0x42: SDB
	0x44: SFC
	0x46: SFB
	ZInfo3: Block no.
0xE501	Parser error
	ZInfo3: SDB number
	ZInfo1: ErrorCode
	1: Parser error: SDB structure
	2: Parser error: SDB is not a valid SDB type.
	ZInfo2: SDB type

Diagnostic entries

Event-ID	Meaning
0xE604	Multiple parametrization of a periphery address for Ethernet PG/OP channel
	ZInfo1: Periphery address
	ZInfo3: 0: Periphery address is input, 1: Periphery address is output
0xE610	Onboard PROFIBUS/MPI: Bus error fixed
	ZInfo1: Interface
	ZInfo2: Not relevant to the user
	ZInfo3: Not relevant to the user
	PK: Not relevant to the user
	DatID: Not relevant to the user
0xE701	Internal error - Please contact the VIPA Hotline!
	ZInfo1: Not relevant to the user
	ZInfo2: Not relevant to the user
	ZInfo3: Not relevant to the user
	DatID: Not relevant to the user
0xE703	Internal error - Please contact the VIPA Hotline!
	ZInfo1: Master system ID
	ZInfo2: Slave address
	ZInfo3: Not relevant to the user
	PK: Not relevant to the user
	DatID: Not relevant to the user
0xE710	Onboard PROFIBUS/MPI: Bus error occurred
	ZInfo1: Interface
	ZInfo2: Not relevant to the user
	ZInfo3: Not relevant to the user
	PK: Not relevant to the user
	DatID: Not relevant to the user
0xE720	Internal error - Please contact the VIPA Hotline!
	ZInfo1: Slave no
	ZInfo2: Not relevant to the user
	ZInfo3: Not relevant to the user
	DatID: Master system ID
0xE721	Internal error - Please contact the VIPA Hotline!
	ZInfo1: Not relevant to the user
	ZInfo2: Master system ID
	ZInfo3: Not relevant to the user
	DatID: Not relevant to the user

Event-ID	Meaning
0xE722	Internal error - Please contact the VIPA Hotline!
	ZInfo1: Channel-Event
	0x00: Channel offline
	0x01: Bus error
	0x02:
	ZInfo2: Master system ID
	DatID: Not relevant to the user
0xE723	Internal error - Please contact the VIPA Hotline!
	ZInfo1: Error code
	0x01: Parameter error
	0x02: Error in configuration
	ZInfo2: Master system ID
	DatID: Not relevant to the user
0xE780	Internal error - Please contact the VIPA Hotline!
0xE801	CMD - Auto command: CMD_START recognized and successfully executed
0xE802	CMD - Auto command: CMD_End recognized and successfully executed
0xE803	CMD - Auto command: WAIT1SECOND recognized and successfully executed
0xE804	CMD - Auto command: WEBPAGE recognized and successfully executed
0xE805	CMD - Auto command: LOAD_PROJECT recognized and successfully executed
0xE806	CMD - Auto command: SAVE_PROJECT recognized and successfully executed
	ZInfo3: Status
	0: Error
	1: OK
	0x8000: Wrong password
0xE807	CMD - Auto command: FACTORY_RESET recognized and successfully executed
0xE808	Internal error - Please contact the VIPA Hotline!
	ZInfo2: Not relevant to the user
	ZInfo3: Not relevant to the user
0xE809	Internal error - Please contact the VIPA Hotline!
	ZInfo3: Not relevant to the user
0xE80A	Internal error - Please contact the VIPA Hotline!
	ZInfo3: Status
	0: OK
	0xFE81: File create error
	0xFEA1: File write error
	0xFE2:

Diagnostics entries

Event-ID	Meaning
0xE80B	CMD - Auto command: DIAGBUF recognized and successfully executed
	ZInfo3: Status
	0: OK
	0xFE81: File create error
	0xFEA1: File write error
	0xFE2:
0xE80C	Internal error - Please contact the VIPA Hotline!
	ZInfo3: Status
	0: OK
	0xFE81: File create error
	0xFE2:
0xE80D	Internal error - Please contact the VIPA Hotline!
0xE80E	CMD - Auto command: SET_NETWORK recognized and successfully executed
0xE80F	Internal error - Please contact the VIPA Hotline!
	ZInfo3: Status
	0: OK
	0xFE81: File create error
	0xFE2:
0xE810	Internal error - Please contact the VIPA Hotline!
0xE811	Internal error - Please contact the VIPA Hotline!
0xE812	Internal error - Please contact the VIPA Hotline!
0xE813	Internal error - Please contact the VIPA Hotline!
0xE816	CMD - Auto command: SAVE_PROJECT recognized but not executed, because the CPU memory is empty
0xE8FB	CMD - Auto command: Error: Initialization of the Ethernet PG/OP channel by means of SET_NETWORK is faulty
0xE8FC	CMD - Auto command: Error: Some IP parameters missing in SET_NETWORK
0xE8FE	CMD - Auto command: Error: CMD_START missing
0xE8FF	CMD - Auto command: Error: Error while reading CMD file (memory card error)
0xE901	Check sum error
	ZInfo1: Not relevant to the user
	ZInfo2: Not relevant to the user
	DatID: Not relevant to the user
0xE902	Internal error - Please contact the VIPA Hotline!
	ZInfo1: Not relevant to the user

Event-ID	Meaning
	ZInfo2: Not relevant to the user
	DatID: Not relevant to the user
0xEA00	Internal error - Please contact the VIPA Hotline!
	PK: Not relevant to the user
	DatID: Not relevant to the user
0xEA01	Internal error - Please contact the VIPA Hotline!
	ZInfo1: Slot
	PK: Not relevant to the user
	DatID: Not relevant to the user
0xEA02	SBUS: Internal error (internal plugged sub module not recognized)
	ZInfo1: Slot
	ZInfo2: Type ID set
	ZInfo3: Type ID
	PK: Not relevant to the user
	DatID: Not relevant to the user
0xEA03	SBUS: Communication error CPU - PROFINET IO controller:
	ZInfo1: Slot
	ZInfo2: Status
	0: OK
	1: Error
	2: Busy
	3: Timeout
	4: Blocked
	5: Unknown
	PK: Not relevant to the user
	DatID: Not relevant to the user
0xEA04	SBUS: Multiple configuration of a periphery address
	ZInfo1: Periphery address
	ZInfo2: Slot
	ZInfo3: Data width
0xEA05	Internal error - Please contact the VIPA Hotline!
0xEA07	Internal error - Please contact the VIPA Hotline!
0xEA08	SBUS: Parameterized input data width unequal to plugged input data width
	ZInfo1: Parameterized input data width
	ZInfo2: Slot
	ZInfo3: Input data width of the plugged module

Diagnostic entries

Event-ID	Meaning
0xEA09	SBUS: Parameterized output data width unequal to plugged output data width
	ZInfo1: Parameterized output data width
	ZInfo2: Slot
	ZInfo3: Output data width of the plugged module
0xEA10	SBUS: Input periphery address outside the periphery area
	ZInfo1: Periphery address
	ZInfo2: Slot
	ZInfo3: Data width
0xEA11	SBUS: Output periphery address outside the periphery area
	ZInfo1: Periphery address
	ZInfo2: Slot
	ZInfo3: Data width
0xEA12	SBUS: Error at writing record set
	ZInfo1: Slot
	ZInfo2: Record set number
	ZInfo3: Record set length
0xEA14	SBUS: Multiple parametrization of a periphery address (diagnostics address)
	ZInfo1: Periphery address
	ZInfo2: Slot
	ZInfo3: Data width
0xEA15	Internal error - Please contact the VIPA Hotline!
	ZInfo2: Slot of the master
0xEA18	SBUS: Error at mapping of the master periphery
	ZInfo2: Slot of the master
0xEA19	Internal error - Please contact the VIPA Hotline!
	ZInfo2: HW slot
	ZInfo3: Interface type
	PK: Not relevant to the user
0xEA1A	DatID: Not relevant to the user
	SBUS: Error at access to the FPGA address table
	ZInfo2: HW slot
	ZInfo3: Table
	0: Reading
	1: Writing
0xEA1A	PK: Not relevant to the user
	DatID: Not relevant to the user

Event-ID	Meaning
0xEA20	Error - RS485 interface is not pre-set to PROFIBUS DP master bus a PROFIBUS DP master is configured
0xEA21	Error - Configuration RS485 interface X2/X3: PROFIBUS DP master is configured but was not found
	ZInfo2: Interface X is faulty configured.
0xEA22	Error - RS485 interface X2 - Value exceeds the limits
	ZInfo2: Project engineering for X2
0xEA23	Error - RS485 interface X3 - Value exceeds the limits
	ZInfo2: Project engineering for X3
0xEA24	Error - Configuration RS485 interface X2/X3: Interface/protocol was not found, default settings are used
	ZInfo2: Project engineering for X2
	ZInfo3: Project engineering for X3
0xEA30	Internal error - Please contact the VIPA Hotline!
	ZInfo1: Status
	ZInfo2: Not relevant to the user
	ZInfo3: Not relevant to the user
0xEA40	Internal error - Please contact the VIPA Hotline!
	OB6100: User slot of the CP
	ZInfo1: Version of the CP
	ZInfo2: Not relevant to the user
	ZInfo3: Not relevant to the user
	DatID: Not relevant to the user
0xEA41	Internal error - Please contact the VIPA Hotline!
	OB: Slot of the CP
	ZInfo1: Version of the CP
	ZInfo2: Not relevant to the user
	ZInfo3: Not relevant to the user
	DatID: Not relevant to the user
0xEA50	PROFINET IO controller: Error in the configuration
	ZInfo1: Rack/slot of the controller
	ZInfo2: Device-No.
	ZInfo3: Slot at the device
	OB: Not relevant to the user
	PK: Not relevant to the user
	DatID: Not relevant to the user
0xEA51	PROFINET IO CONTROLLER: There is no PROFINET IO controller at the configured slot

Diagnostic entries

Event-ID	Meaning
	ZInfo1: Rack/slot of the controller
	ZInfo2: Recognized ID at the configured slot
	PK: Not relevant to the user
	DatID: Not relevant to the user
0xEA53	PROFINET IO CONTROLLER: PROFINET configuration: There are too many PROFINET IO devices configured
	ZInfo1: Number of configured devices
	ZInfo2: Slot
	ZInfo3: Maximum possible number of devices
0xEA54	PROFINET IO controller: IO controller reports multiple parametrization of a periphery address
	ZInfo1: Periphery address
	ZInfo2: Slot
	ZInfo3: Data width
	PK: Not relevant to the user
	DatID: Not relevant to the user
0xEA61	Internal error - Please contact the VIPA Hotline!
	PK: Controller slot
	OB: File no.
	DatID: Line
	ZInfo1: Firmware major version
	ZInfo2: Firmware minor version
0xEA62	Internal error - Please contact the VIPA Hotline!
	PK: Controller slot
	OB: File no.
	DatID: Line
	ZInfo1: Firmware major version
	ZInfo2: Firmware minor version
0xEA63	Internal error - Please contact the VIPA Hotline!
	PK: Controller slot
	OB: File no.
	DatID: Line
	ZInfo1: Firmware major version
	ZInfo2: Firmware minor version
0xEA64	PROFINET IO controller/EtherCAT-CP: Error in the configuration
	ZInfo1: Too many devices
	ZInfo1: Too many devices per second

Event-ID	Meaning
	ZInfo1: Too many input bytes per ms
	ZInfo1: Too many output bytes per ms
	ZInfo1: Too many input bytes per ms
	ZInfo1: Too many output bytes per device
	ZInfo1: Too many productive connections
	ZInfo1: Too many input bytes in the process image
	ZInfo1: Too many output bytes in the process image
	ZInfo1: Configuration not available
	ZInfo1: Configuration not valid
	ZInfo1: Refresh time too short
	ZInfo1: Cycle time too big
	ZInfo1: Not valid device number
	ZInfo1: CPU is configured as I device
	ZInfo1: Use different method to obtain IP address Is not supported for the IP address of the controller
	ZInfo2: Incompatible configuration (SDB version not supported)
	ZInfo2: EtherCAT: EoE configured but not supported
0xEA65	Internal error - Please contact the VIPA Hotline!
	PK: Platform
	0: none
	8: CP
	16: CPU
	9: Ethernet CP
	10: PROFINET CP
	12: EtherCAT CP
	ZInfo1: ServiceID in which the error occurred
	ZInfo2: Command in which the error occurred
	1: Request
	2: Connect
	3: Error
0xEA66	PROFINET IO controller: Error in communication stack
	PK: Rackslot
	OB: StackError.Service
	DatID: StackError.DeviceRef
	ZInfo1: StackError.Error.Code
	ZInfo2: StackError.Error.Detail

Diagnostic entries

Event-ID	Meaning
	ZInfo3: StackError.Error.AdditionalDetail
	ZInfo3: StackError.Error.AreaCode
0xEA67	PROFINET IO controller: Error reading record set
	PK: Error type
	0: Record set error local
	1: Record set error stack
	2: Record set error station
	OB: Rackslot controller
	DatID: Device
	ZInfo1: Record set number
	ZInfo2: Record set handle (caller)
	ZInfo3: Internal error code from PN stack
0xEA68	PROFINET IO controller: Error at writing record set
	PK: Error type
	0: Record set error local
	1: Record set error stack
	2: Record set error station
	OB: Rack/slot of the controller
	DatID: Device
	ZInfo1: Record set number
	ZInfo2: Record set handle (caller)
	ZInfo3: Internal error code from PN stack
0xEA69	Internal error - Please contact the VIPA Hotline!
	ZInfo1: Minimum version for the FPGA
	ZInfo2: Loaded FPGA version
0xEA6A	PROFINET IO controller: Service error in communication stack
	PK: Rackslot
	OB: Service ID
	ZInfo1: ServiceError.Code
	ZInfo2: ServiceError.Detail
	ZInfo3: StackError.Error.AdditionalDetail
	ZInfo3: ServiceError.AreaCode
0xEA6B	PROFINET IO controller: Faulty vendor ID
	ZInfo1: Device ID
	ZInfo2: Not relevant to the user
	ZInfo3: Not relevant to the user

Event-ID	Meaning
	OB: PLC-Mode
	0x00: Unknown
	0x01: STOP update
	0x02: STOP overall reset
	0x03: STOP initialization
	0x04: STOP internal
	0x06: Cold start
	0x07: Warm start
	0x08: Run
	0x0A: Halt
	0x0D: Malfunction
	0xFD:
	0xFE:
	0xFF:
	PK: Rackslot
	DatID: Not relevant to the user
0xEA6C	PROFINET IO controller: Faulty device ID
	ZInfo1: Device ID
	PK: Rackslot
	OB: PLC-Mode
	0x00: Unknown
	0x01: STOP update
	0x02: STOP overall reset
	0x03: STOP initialization
	0x04: STOP internal
	0x06: Cold start
	0x07: Warm start
	0x08: Run
	0x0A: Halt
	0x0D: Malfunction
	0xFD:
	0xFE:
	0xFF:
0xEA6D	PROFINET IO controller: No empty Name
	ZInfo1: Device ID
	ZInfo2: Not relevant to the user

Diagnostic entries

Event-ID	Meaning
	ZInfo3: Not relevant to the user
	OB: PLC-Mode
	0x00: Unknown
	0x01: STOP update
	0x02: STOP overall reset
	0x03: STOP initialization
	0x04: STOP internal
	0x06: Cold start
	0x07: Warm start
	0x08: Run
	0x0A: Halt
	0x0D: Malfunction
	0xFD:
	0xFE:
	0xFF:
	PK: Rackslot
	DatID: Not relevant to the user
0xEA6E	PROFINET IO controller: Waiting for RPC answer
	ZInfo1: Device ID
	ZInfo2: Not relevant to the user
	ZInfo3: Not relevant to the user
	OB: PLC-Mode
	0x00: Unknown
	0x01: STOP update
	0x02: STOP overall reset
	0x03: STOP initialization
	0x04: STOP internal
	0x06: Cold start
	0x07: Warm start
	0x08: Run
	0x0A: Halt
	0x0D: Malfunction
	0xFD:
	0xFE:
	0xFF:
	PK: Rackslot

Event-ID	Meaning
	DatID: Not relevant to the user
0xEA6F	PROFINET IO controller: PROFINET module deviation
	ZInfo1: Device ID
	ZInfo2: Not relevant to the user
	ZInfo3: Not relevant to the user
	OB: PLC-Mode
	0x00: Unknown
	0x01: STOP update
	0x02: STOP overall reset
	0x03: STOP initialization
	0x04: STOP internal
	0x06: Cold start
	0x07: Warm start
	0x08: Run
	0x0A: Halt
	0x0D: Malfunction
	0xFD:
	0xFE:
	0xFF:
	PK: Rackslot
	DatID: Not relevant to the user
0xEA81	Internal error - Please contact the VIPA Hotline!
	ZInfo1: Filenamehash[0-3]
	ZInfo2: Filenamehash[4-7]
	ZInfo3: Line
	OB: Not relevant to the user
	PK: Not relevant to the user
	DatID: SvnRevision
0xEA82	Internal error - Please contact the VIPA Hotline!
	ZInfo1: Filenamehash[0-3]
	ZInfo2: Filenamehash[4-7]
	ZInfo3: Line
	OB: Not relevant to the user
	PK: Not relevant to the user
	DatID: SvnRevision
0xEA83	Internal error - Please contact the VIPA Hotline!

Diagnostic entries

Event-ID	Meaning
	ZInfo1: Filenamehash[0-3]
	ZInfo2: Filenamehash[4-7]
	ZInfo3: Line
	OB: Not relevant to the user
	PK: Not relevant to the user
	DatID: SvnRevision
0xEA91	Internal error - Please contact the VIP A Hotline!
	ZInfo1: Filenamehash[0-3]
	ZInfo2: Filenamehash[4-7]
	ZInfo3: Line
	OB: Current OB number
	PK: Core status
	0: INIT
	1: STOP
	2: READY
	3: PAUSE
	4: RUN
	DatID: Current job number
0xEA92	Internal error - Please contact the VIP A Hotline!
	ZInfo1: Filenamehash[0-3]
	ZInfo2: Filenamehash[4-7]
	ZInfo3: Line
	OB: Current OB number
	PK: Core status
	0: INIT
	1: STOP
	2: READY
	3: PAUSE
	4: RUN
	DatID: Current job number
0xEA93	Internal error - Please contact the VIP A Hotline!
	ZInfo1: Filenamehash[0-3]
	ZInfo2: Filenamehash[4-7]
	ZInfo3: Line
	OB: Current OB number
	PK: Core status

Event-ID	Meaning
	0: INIT
	1: STOP
	2: READY
	3: PAUSE
	4: RUN
	DatID: Current job number
0xEA97	Internal error - Please contact the VIPA Hotline!
	ZInfo3: Slot
0xEA98	Timeout at waiting for reboot of a SBUS module (server)
	PK: Not relevant to the user
	DatID: Not relevant to the user
0xEA99	Error at file reading via SBUS
	ZInfo3: Slot
	PK: Not relevant to the user
	DatID: Not relevant to the user
0xEAA0	Emac Error occurred
	OB: Current PLC mode
	0x00: Unknown
	0x01: STOP update
	0x02: STOP overall reset
	0x03: STOP initialization
	0x04: STOP internal
	0x06: Cold start
	0x07: Warm start
	0x08: Run
	0x0A: Halt
	0x0D: Malfunction
	0xFD:
	0xFE:
	0xFF:
	ZInfo1: Diagnostics address of the master
	ZInfo2: no Rx queue is full
	ZInfo2: No send buffer available
	ZInfo2: Send stream was cut off; sending failed
	ZInfo2: Exhausted retries
	ZInfo2: No receive buffer available in Emac DMA

Diagnostic entries

Event-ID	Meaning
	ZInfo2: Emac DMA transfer interrupted
	ZInfo2: Queue overflow
	ZInfo2: Unexpected frame received
	ZInfo3: Number of errors, which occurred
0xEAB0	Link mode not valid
	ZInfo1: Diagnostics address of the master
	ZInfo2: Current connection mode
	0x01: 10Mbit full-duplex
	0x02: 100Mbit half-duplex
	0x03: 100Mbit full-duplex
	0x05: 10Mbit half-duplex
	0xFF: Link mode undefined
	OB: Current PLC mode
	0: Run
	1: Stop
	2: MRES
0xEAC0	Internal error - Please contact the VIPA Hotline!
	ZInfo1: Error code
	0x01:
	0x02:
	0x03:
	0x04:
	0x05:
	0x06:
	0x07:
	0x08:
0xEAD0	Error in configuration SyncUnit
0xEB03	SLIO error: IO mapping
	ZInfo1: Type of error
	0x01: SDB parser error
	0x02: Configured address already used
	0x03: Mapping error
	PK: Not relevant to the user
	DatID: Not relevant to the user
	ZInfo2: Slot (0=not be determined)
0xEB05	SLIO error: Bus structure for Isochron process image not suitable

Event-ID	Meaning
	PK: Not relevant to the user
	DatID: Not relevant to the user
0xEB10	SLIO error: Bus error
	ZInfo1: Type of error
	0x60: Bus enumeration error
	0x80: General error
	0x81: Queue execution error
	0x82: Error interrupt
	PK: Not relevant to the user
	DatID: Not relevant to the user
0xEB11	SLIO error during bus initialization
	PK: Not relevant to the user
	DatID: Not relevant to the user
0xEB20	SLIO error: Interrupt information undefined
0xEB21	SLIO error: Accessing configuration data
	ZInfo2: Not relevant to the user
	ZInfo3: Not relevant to the user
	DatID: Not relevant to the user
0xEC03	EtherCAT: Error in configuration
	ZInfo1: Error code
	1: Number of slaves is not supported.
	2: Master system ID not valid
	03:00
	4: Master configuration not valid
	5: Master type not valid
	6: Slave diagnostic address invalid
	7: Slave address not valid
	8: Slave module IO configuration invalid.
	9: Logical address already in use.
	10:00
	11: IO mapping error
	12: Error
	13: Error in initialising the EtherCAT stack (is entered by the CP)
	PK: Not relevant to the user
	DatID: Not relevant to the user
0xEC04	EtherCAT: Multiple configuration of a periphery address

Diagnostic entries

Event-ID	Meaning
	ZInfo1: Periphery address
	ZInfo2: Slot
	PK: Not relevant to the user
	DatID: Not relevant to the user
0xEC05	EtherCAT: Check the set DC mode of the YASKAWA Sigma 5/7 drive
	PK: Not relevant to the user
	OB: PLC-Mode
	0x00: Unknown
	0x01: STOP update
	0x02: STOP overall reset
	0x03: STOP initialization
	0x04: STOP internal
	0x06: Cold start
	0x07: Warm start
	0x08: Run
	0x0A: Halt
	0x0D: Malfunction
	0xFD:
	0xFE:
	0xFF:
	DatID: Not relevant to the user
	ZInfo1: Station address of the EtherCAT device
	ZInfo2: Error code
	1: WARNING: For the drive the DC Beckhoff mode is recommended (DC reference clock is not in Beckhoff Mode)
	2: NOTE: For the drive the DC Beckhoff mode is recommended (DC reference clock is not in Beckhoff Mode)
	3: The station address could not be determined for checking (station address in Zinfo1 is accordingly 0)
	4: The slave information could not be determined for checking (station address in Zinfo1 is accordingly 0)
	5: The EtherCAT status of the drive could not be determined
	6: Error when sending the SDO request (for further information, the (subsequent) event with the ID 0xED60 is to be analysed on the CP)
	7: Drive returns error in the SDO response (for further information, the (subsequent) event with the ID 0xED60 is to be analysed on the CP)
	8: SDO timeout, DC mode could not be determined (for further information, the (subsequent) event with the ID 0xED60 is to be analysed on the CP)
	ZInfo3: Not relevant to the user

Event-ID	Meaning
0xEC10	EtherCAT: Restoration bus with its slaves
	ZInfo1: Old status
	0x00: Undefined/Unkown
	0x01: INIT
	0x02: PreOp
	0x03: BootStrap
	0x04: SafeOp
	0x08: Op
	ZInfo1: New status
	0x00: Undefined/Unkown
	0x01: INIT
	0x02: PreOp
	0x03: BootStrap
	0x04: SafeOp
	0x08: Op
	ZInfo2: Diagnostics address of the station
	ZInfo3: Number of stations, which are not in the same state as the master
	DatID: Input address
	DatID: Output address
	DatID: Station not available
DatID: Station available	
0xEC11	EtherCAT: Restoration bus with missing slaves
	ZInfo1: Old status
	0x00: Undefined/Unkown
	0x01: INIT
	0x02: PreOp
	0x03: BootStrap
	0x04: SafeOp
	0x08: Op
	ZInfo1: New status
	0x00: Undefined/Unkown
	0x01: INIT
	0x02: PreOp
	0x03: BootStrap
	0x04: SafeOp
	0x08: Op

Diagnostic entries

Event-ID	Meaning
	ZInfo2: Diagnostics address of the master
	ZInfo3: Number of stations, which are not in the same state as the master
	DatID: Input address
	DatID: Output address
	DatID: Station not available
	DatID: Station available
0xEC12	EtherCAT: Restoration slave
	ZInfo1: Old status
	0x00: Undefined/Unkown
	0x01: INIT
	0x02: PreOp
	0x03: BootStrap
	0x04: SafeOp
	0x08: Op
	ZInfo1: New status
	0x00: Undefined/Unkown
	0x01: INIT
	0x02: PreOp
	0x03: BootStrap
	0x04: SafeOp
	0x08: Op
	ZInfo2: Diagnostics address of the station
	ZInfo3: AL Statuscode
	DatID: Input address
	DatID: Output address
	DatID: Station not available
	DatID: Station available
0xEC30	EtherCAT: Topology OK
	ZInfo2: Diagnostics address of the master
0xEC50	EtherCAT: DC out of sync
	ZInfo1: Diagnostics address of the master
	ZInfo3: Table
	0: DC master out of sync
	1: DC slaves out of Sync
0xED10	EtherCAT: Bus failure
	ZInfo1: Old status

Event-ID	Meaning
	0x00: Undefined/Unkown
	0x01: INIT
	0x02: PreOp
	0x03: BootStrap
	0x04: SafeOp
	0x08: Op
	ZInfo1: New status
	0x00: Undefined/Unkown
	0x01: INIT
	0x02: PreOp
	0x03: BootStrap
	0x04: SafeOp
	0x08: Op
	ZInfo2: Diagnostic address of the master
	ZInfo3: Number of stations, which are not in the same state as the master
	DatID: Input address
	DatID: Output address
	DatID: Station not available
	DatID: Station available
0xED12	EtherCAT: Slave failure
	ZInfo1: Old status
	0x00: Undefined/Unkown
	0x01: INIT
	0x02: PreOp
	0x03: BootStrap
	0x04: SafeOp
	0x08: Op
	ZInfo1: New status
	0x00: Undefined/Unkown
	0x01: INIT
	0x02: PreOp
	0x03: BootStrap
	0x04: SafeOp
	0x08: Op
	ZInfo2: Diagnostics address of the station
	ZInfo3: AIStatusCode

Diagnostic entries

Event-ID	Meaning
	0x0000: No Error
	0x0001: Unspecified error
	0x0011: Invalid requested status change
	0x0012: Unknown requested status
	0x0013: Bootstrap not supported
	0x0014: No valid firmware
	0x0015: Invalid mailbox configuration
	0x0016: Invalid mailbox configuration
	0x0017: Invalid sync manager configuration
	0x0018: No valid inputs available
	0x0019: No valid outputs available
	0x001A: Synchronisation error
	0x001B: Sync manager watchdog
	0x001C: Invalid sync manager types
	0x001D: Invalid output configuration
	0x001E: Invalid input configuration
	0x001F: Invalid watchdog configuration
	0x0020: Slave needs cold start
	0x0021: Slave needs INIT
	0x0022: Slave needs PreOp
	0x0023: Slave needs SafeOp
	0x002D: Invalid output FMMU configuration
	0x002E: Invalid input FMMU configuration
	0x0030: Invalid DC Sync configuration
	0x0031: Invalid DC satch configuration
	0x0032: PLL error
	0x0033: Invalid DC IO error
	0x0034: Invalid DC timeout error
	0x0042: Mailbox-EOE
	0x0043: Mailbox-COE
	0x0044: Mailbox-FOE
	0x0045: Mailbox-SOE
	0x004F: Mailbox-VOE
	DatID: Input address
	DatID: Output address
	DatID: Station not available

Event-ID	Meaning
	DatID: Station available
0xED20	EtherCAT: Bus state change without calling OB 86
	ZInfo1: Old status
	0x00: Undefined/Unkown
	0x01: INIT
	0x02: PreOp
	0x03: BootStrap
	0x04: SafeOp
	0x08: Op
	ZInfo1: New status
	0x00: Undefined/Unkown
	0x01: INIT
	0x02: PreOp
	0x03: BootStrap
	0x04: SafeOp
	0x08: Op
	ZInfo2: Diagnostics address of the master
	ZInfo3: Number of stations, which are not in the same state as the master
	DatID: Input address
	DatID: Output address
	DatID: Station not available
	DatID: Station available
0xED21	EtherCAT: Faulty bus status change
	ZInfo1: Old status
	0x00: Undefined/Unkown
	0x01: INIT
	0x02: PreOp
	0x03: BootStrap
	0x04: SafeOp
	0x08: Op
	ZInfo1: New status
	0x00: Undefined/Unkown
	0x01: INIT
	0x02: PreOp
	0x03: BootStrap
	0x04: SafeOp

Diagnostic entries

Event-ID	Meaning
	0x08: Op
	ZInfo2: Diagnostics address of the master
	ZInfo3: Error code
	0x0008: Busy
	0x000B: Invalid parameters
	0x000E: Invalid status
	0x010: Timeout
	DatID: Input address
	DatID: Output address
	DatID: Station not available
	DatID: Station available
0xED22	EtherCAT: Slave state change without calling OB 86
	ZInfo1: Old status
	0x00: Undefined/Unkown
	0x01: INIT
	0x02: PreOp
	0x03: BootStrap
	0x04: SafeOp
	0x08: Op
	ZInfo1: New status
	0x00: Undefined/Unkown
	0x01: INIT
	0x02: PreOp
	0x03: BootStrap
	0x04: SafeOp
	0x08: Op
	ZInfo2: Diagnostics address of the station
	ZInfo3: AIStatusCode
	0x0000: No Error
	0x0001: Unspecified error
	0x0011: Invalid requested status change
	0x0012: Unknown requested status
	0x0013: Bootstrap not supported
	0x0014: No valid firmware
	0x0015: Invalid mailbox configuration
	0x0016: Invalid mailbox configuration

Event-ID	Meaning
	0x0017: Invalid sync manager configuration
	0x0018: No valid inputs available
	0x0019: No valid outputs available
	0x001A: Synchronisation error
	0x001B: Sync manager watchdog
	0x001C: Invalid sync manager types
	0x001D: Invalid output configuration
	0x001E: Invalid input configuration
	0x001F: Invalid watchdog configuration
	0x0020: Slave needs cold start
	0x0021: Slave needs INIT
	0x0022: Slave needs PreOp
	0x0023: Slave needs SafeOp
	0x002D: Invalid output FMMU configuration
	0x002E: Invalid input FMMU configuration
	0x0030: Invalid DC Sync configuration
	0x0031: Invalid DC satch configuration
	0x0032: PLL error
	0x0033: Invalid DC IO error
	0x0034: Invalid DC timeout error
	0x0042: Mailbox-EOE
	0x0043: Mailbox-COE
	0x0044: Mailbox-FOE
	0x0045: Mailbox-SOE
	0x004F: Mailbox-VOE
	DatID: Input address
	DatID: Output address
	DatID: Station not available
	DatID: Station available
0xED23	EtherCAT: Timeout while changing the master status to OP, after CPU has changed to RUN
	OB: PLC-Mode
	0x00: Unknown
	0x01: STOP update
	0x02: STOP overall reset
	0x03: STOP initialization
	0x04: STOP internal

Diagnostic entries

Event-ID	Meaning
	0x06: Cold start
	0x07: Warm start
	0x08: Run
	0x0A: Halt
	0x0D: Malfunction
	0xFD:
	0xFE:
	0xFF:
	ZInfo1: Master status
	0x00: Undefined/Unkown
	0x01: INIT
	0x02: PreOp
	0x03: BootStrap
	0x04: SafeOp
	0x08: Op
	ZInfo2: There is an EtherCAT configuration
	0: There is no EC configuration
	1: There is an EC configuration
	ZInfo3: DC in sync
	0: not in sync
	1: in sync
0xED30	EtherCAT: Topology deviation
	ZInfo2: Diagnostics address of the master
0xED31	EtherCAT: Overflow of the interrupt queue
	ZInfo2: Diagnostics address of the master
0xED50	EtherCAT: DC slaves in sync
	ZInfo1: Diagnostics address of the master
	ZInfo3: Table
	0: DC master in sync
	1: DC slaves in sync
0xED60	EtherCAT: Diagnostics buffer CP: Slave state change
	OB: PLC-Mode
	0x00: Unknown
	0x01: STOP update
	0x02: STOP overall reset
	0x03: STOP initialization

Event-ID	Meaning
	0x04: STOP internal
	0x06: Cold start
	0x07: Warm start
	0x08: Run
	0x0A: Halt
	0x0D: Malfunction
	0xFD:
	0xFE:
	0xFF:
	ZInfo1: New status
	0x00: Undefined/Unkown
	0x01: INIT
	0x02: PreOp
	0x03: BootStrap
	0x04: SafeOp
	0x08: Op
	ZInfo2: Slave address
	ZInfo3: AIStatusCode
	0x0000: No Error
	0x0001: Unspecified error
	0x0011: Invalid requested status change
	0x0012: Unknown requested status
	0x0013: Bootstrap not supported
	0x0014: No valid firmware
	0x0015: Invalid mailbox configuration
	0x0016: Invalid mailbox configuration
	0x0017: Invalid sync manager configuration
	0x0018: No valid inputs available
	0x0019: No valid outputs available
	0x001A: Synchronisation error
	0x001B: Sync manager watchdog
	0x001C: Invalid sync manager types
	0x001D: Invalid output configuration
	0x001E: Invalid input configuration
	0x001F: Invalid watchdog configuration
	0x0020: Slave needs cold start

Diagnostic entries

Event-ID	Meaning
	0x0021: Slave needs INIT
	0x0022: Slave needs PreOp
	0x0023: Slave needs SafeOp
	0x002D: Invalid output FMMU configuration
	0x002E: Invalid input FMMU configuration
	0x0030: Invalid DC Sync configuration
	0x0031: Invalid DC satch configuration
	0x0032: PLL error
	0x0033: Invalid DC IO error
	0x0034: Invalid DC timeout error
	0x0042: Mailbox-EOE
	0x0043: Mailbox-COE
	0x0044: Mailbox-FOE
	0x0045: Mailbox-SOE
	0x004F: Mailbox-VOE
	DatID: Cause for slave status change
	0: Regular slave status change
	1: Slave failure
	2: Restoration slave
	3: Slave is in an error state
	4: Slave has unexpectedly changed its status
0xED61	EtherCAT: Diagnostics buffer CP: CoE emergency
	PK: EtherCAT station address (low byte)
	OB: EtherCAT station address (high byte)
	DatID: Error code
	ZInfo1: Error register
	ZInfo1: MEF-Byte1
	ZInfo2: MEF-Byte2
	ZInfo2: MEF-Byte3
	ZInfo3: MEF-Byte4
	ZInfo3: MEF-Byte5
0xED62	EtherCAT: Diagnostics buffer CP: Error on SDO access
	PK: EtherCAT station address (low byte)
	OB: EtherCAT station address (high-byte)
	DatID: Subindex
	ZInfo1: Index

Event-ID	Meaning
	ZInfo2: SDOErrorCode (high word)
	ZInfo3: SDOErrorCode (low word)
0xED63	EtherCAT: Diagnostics buffer CP: Error in the response to an INIT command
	PK: EtherCAT station address (low byte)
	OB: EtherCAT station address (high byte)
	ZInfo1: Error type
	1: No response
	2: Validation error
	3: INIT command failed, requested station could not be reached
0xED70	EtherCAT: Diagnostics buffer CP: Twice HotConnect group found
	OB: PLC-Mode
	0x00: Unknown
	0x01: STOP update
	0x02: STOP overall reset
	0x03: STOP initialization
	0x04: STOP internal
	0x06: Cold start
	0x07: Warm start
	0x08: Run
	0x0A: Halt
	0x0D: Malfunction
	0xFD:
	0xFE:
	0xFF:
	ZInfo1: Diagnostics address of the master
	ZInfo2: EtherCAT station address
0xEE00	Additional information at UNDEF_OPCODE
	ZInfo1: Not relevant to the user
	ZInfo2: Not relevant to the user
	ZInfo3: Not relevant to the user
	OB: Not relevant to the user
	DatID: Not relevant to the user
0xEE01	Internal error - Please contact the VIPA Hotline!
	ZInfo3: SFB number
0xEEEE	CPU was completely overall reset, since after PowerON the start-up could not be finished
0xEF00	Internal error - Please contact the VIPA Hotline!

Diagnostic entries

Event-ID	Meaning
	DatID: Not relevant to the user
0xEF01	Internal error - Please contact the VIPA Hotline!
	DatID: Not relevant to the user
	ZInfo1: Not relevant to the user
	ZInfo2: Not relevant to the user
	ZInfo3: Not relevant to the user
0xEF11	Internal error - Please contact the VIPA Hotline!
0xEF12	Internal error - Please contact the VIPA Hotline!
0xEF13	Internal error - Please contact the VIPA Hotline!
0xEFFE	Internal error - Please contact the VIPA Hotline!
	ZInfo3: Not relevant to the user
	PK: Not relevant to the user
	DatID: Not relevant to the user
0xEFFF	Internal error - Please contact the VIPA Hotline!
	ZInfo3: Not relevant to the user
	PK: Not relevant to the user
	DatID: Not relevant to the user

5 Deployment I/O periphery

5.1 Overview

Project engineering and parametrization

- On this CPU the connectors for digital respectively analog signal and *Technological functions* are combined in a one casing.
- The project engineering happens in the Siemens SIMATIC Manager as CPU 314C-2 PN/DP from Siemens (314-6EH04-0AB0 V3.3). Here the CPU 013-CCF0R00 is parameterized via the 'Properties' dialog of the Siemens CPU 314C-2 PN/DP.
- For parametrization of the digital I/O periphery and the *technological functions* the corresponding sub modules of the CPU 314C-2 PN/DP is to be used.
- The controlling of the operating modes of the *technological functions* happens by means of handling blocks of the user program.

I/O periphery

- The integrated I/Os of the CPU may be used for *technological functions* or as standard periphery.
- *Technological functions* and standard periphery may be used simultaneously with appropriate hardware.
- Read access to inputs used by *technological functions* is possible.
- Write access to used outputs is not possible.
- ↪ 'Analog input' on page 128
 - 2xUx12Bit (0 ... 10V)
 - The analog channels of the module are not isolated to the electronic power supply.
 - The analog part has no status indication
- ↪ 'Digital input' on page 132
 - 16xDC 24V
 - Interrupt functions parameterizable
 - Status indication via LEDs
- ↪ 'Digital output' on page 135
 - 12xDC 24V, 0.5A
 - Status indication via LEDs

Technological functions

- ↪ 'Counting' on page 138
 - 4 channels
 - Count once
 - Count continuously
 - Count Periodically
 - Control by the user program ↪ 'SFB 47 - COUNT - Counter controlling' on page 142
- ↪ 'Frequency measurement' on page 167
 - 4 channels
 - Control by the user program ↪ 'SFB 48 - FREQUENC - Frequency measurement' on page 170
- ↪ 'Pulse width modulation - PWM' on page 176
 - 2 channels
 - Control by the user program ↪ 'SFB 49 - PULSE - Pulse width modulation' on page 178

5.2 Address assignment

Sub module	Input address	Access	Assignment
AI5/AO2	800	WORD	Analog input channel 0 (X4)
	802	WORD	Analog input channel 1 (X4)

Sub module	Input address	Access	Assignment
DI24/DO16	136	BYTE	Digital input I+0.0 ... I+0.7 (X4)
	137	BYTE	Digital input I+1.0 ... I+1.7 (X4)

Sub module	Input address	Access	Assignment
Counter	816	DINT	Channel 0: Counter value / Frequency value
	820	DINT	Channel 1: Counter value / Frequency value
	824	DINT	Channel 2: Counter value / Frequency value
	828	DINT	Channel 3: Counter value / Frequency value

Sub module	Output address	Access	Assignment
Counter	816	DWORD	reserved
	820	DWORD	reserved
	824	DWORD	reserved
	828	DWORD	reserved

Sub module	Output address	Access	Assignment
DI24/DO16	136	BYTE	Digital output Q+0.0 ... Q+0.7 (X5)
	137	BYTE	Digital output Q+1.0 ... Q+1.3 (X5)

5.3 Analog input

5.3.1 Properties

- 2xUx12Bit (0 ... 10V) fixed.
- The analog channels of the module are not isolated to the electronic power supply.
- The analog part has no status indication.



Temporarily not used analog inputs must be connected to the concerning ground.

5.3.2 Analog value representation

Number representation in Siemens S7 format

Resolu- tion	Analog value - twos complement															
	High byte (byte 0)								Low byte (byte 1)							
Bit number	15	14	13	12	11	10	9	8	7	6	5	4	3	2	1	0
Value	SG	2 ¹⁴	2 ¹³	2 ¹²	2 ¹¹	2 ¹⁰	2 ⁹	2 ⁸	2 ⁷	2 ⁶	2 ⁵	2 ⁴	2 ³	2 ²	2 ¹	2 ⁰
11Bit+sign	SG	Measuring value										X*	X*	X*	X*	
* The lowest value irrelevant bits of the output value (0) are marked with "X".																

Sign bit (SG)

Here it is essential:

- Bit 15 = "0": → positive value
- Bit 15 = "1": → negative value

Behavior at error

As soon as a measured value exceeds the overdrive region respectively falls below the underdrive region, the following value is issued:

- Measuring value > end of overdrive region:
32767 (7FFFh)
- Measuring value < end of underdrive region:
-32768 (8000h)

At a parameterization error the value 32767 (7FFFh) is issued.

When leaving the defined range during analog output 0V respectively 0A is issued.

Voltage measurement

0 ... 10V

Measuring range	Voltage (U)	Decimal (D)	Hex	Range	Formulas
0 ... 10V	> 11.759V	32767	7FFFh	overflow	$D = 27648 \cdot \frac{U}{10}$
	11.759V	32511	7EFFh	overdrive range	
	10V	27648	6C00h	nominal range	$U = D \cdot \frac{10}{27648}$
	5V	13824	3600h		
	0V	0	0000h		
	-0.8V	-2212	F75Ch	underdrive range	D: decimal value
	< -0.8V	-32768	8000h	underflow	U: voltage value

5.3.3 Wiring

X4: Connector

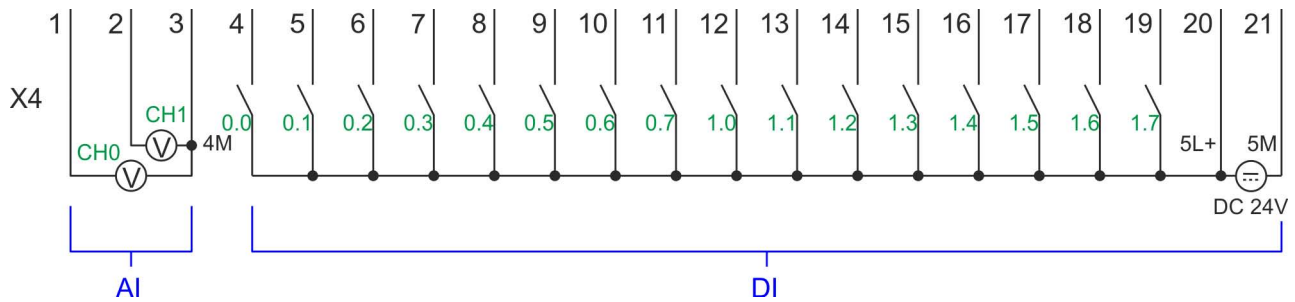

Pos.	Function	Type	Description
1	AI 0	I	AI0: Analog input AI 0
2	AI 1	I	AI1: Analog input AI 1
3	Analog 0V	I	4M: GND for analog inputs
4	DI 0	I	+0.0: Digital input DI 0 / Counter 0 (A) *
5	DI 1	I	+0.1: Digital input DI 1 / Counter 0 (B) / Frequency 0 *
6	DI 2	I	+0.2: Digital input DI 2
7	DI 3	I	+0.3: Digital input DI 3 / Counter 1 (A) *
8	DI 4	I	+0.4: Digital input DI 4 / Counter 1 (B) / Frequency 1 *
9	DI 5	I	+0.5: Digital input DI 5
10	DI 6	I	+0.6: Digital input DI 6 / Counter 2 (A) *
11	DI 7	I	+0.7: Digital input DI 7 / Counter 2 (B) / Frequency 2 *
12	DI 8	I	+1.0: Digital input DI 8
13	DI 9	I	+1.1: Digital input DI 9 / Counter 3 (A) *
14	DI 10	I	+1.2: Digital input DI 10 / Counter 3 (B) / Frequency 3 *
15	DI 11	I	+1.3: Digital input DI 11 / Gate 3 *
16	DI 12	I	+1.4: Digital input DI 12
17	DI 13	I	+1.5: Digital input DI 13
18	DI 14	I	+1.6: Digital input DI 14
19	DI 15	I	+1.7: Digital input DI 15 / Latch 3 *
20	DC 24V	I	5L+: DC 24V for onboard DI power section supply
21	0 V	I	5M: GND for onboard DI power section supply

*) Max. input frequency 100kHz otherwise 1kHz.

Cables for analog signals

For the analog signals you have to use isolated cables. With this the interferences can be reduced. The shield of the analog cables should be grounded at both ends. If there are potential differences between the cables, a potential compensation current can flow, which could disturb the analog signals. In this case, you should only ground the shield at one end of the cable.



Temporarily not used analog inputs must be connected to the concerning ground.

5.3.4 Parametrization

5.3.4.1 Adress assignment

Sub module	Input address	Access	Assignment
AI5/AO2	800	WORD	Analog input channel 0 (X4)
	802	WORD	Analog input channel 1 (X4)

5.3.4.2 Filter

Parameter hardware configuration

The analog input part has a filter integrated. The parametrization of the filter happens in the Siemens SIMATIC Manager via the parameter 'Integration time'. The default value of the filter is 1000ms. The following values can be entered:

- 'Input 0 ≙ Channel 0'
'Input 1 ≙ Channel 1'
 - 'Integration time 2.5ms' ≙ 2ms (no filter)
 - 'Integration time 16.6ms' ≙ 100ms (small filter)
 - 'Integration time 20ms' ≙ 1000ms (medium filter)

Parametrization during runtime

By using the record set 1 of the SFC 55 "WR_PARM" you may alter the parametrization in the module during runtime.



The time needed until the new parametrization is valid can last up to 2ms. During this time, the measuring value output is 7FFFFh.

Record set 1

Byte	Bit 7 ... Bit 0	Default
0	Bit 7...0: reserved	00h
1	Filter <ul style="list-style-type: none"> ■ Bit 1, 0: Analog input channel 0 Bit 3, 2: Analog input channel 1 <ul style="list-style-type: none"> – 00b: 'Integration time 2.5ms' ≙ 2ms (no filter) – 01b: 'Integration time 16.6ms' ≙ 100ms (small filter) – 10b: 'Integration time 20ms' ≙ 1000ms (medium filter) ■ Bit 7...4: reserved 	10h
2...12	Bit 7...0: reserved	

Digital input > Properties

5.4 Digital input

5.4.1 Properties

- 16xDC 24V
- Maximum input frequency
 - 10 inputs: 100kHz
 - 6 inputs: 1kHz
- Interrupt functions parameterizable
- Status indication via LEDs

5.4.2 Wiring

X4: Connector

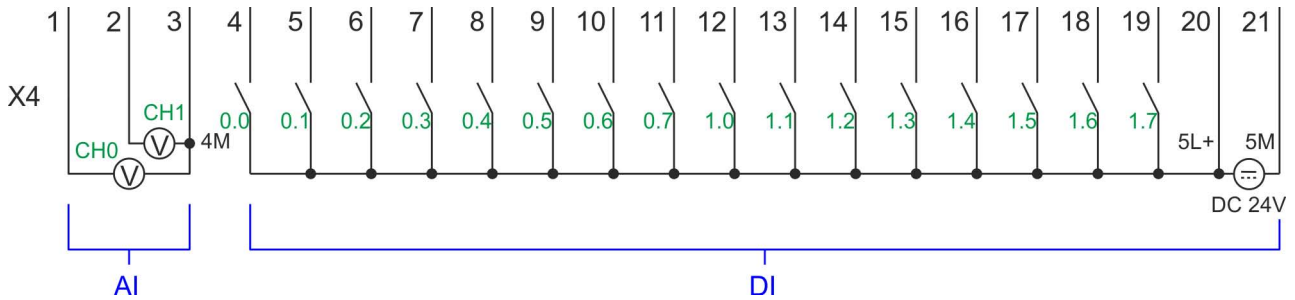

Pos.	Function	Type	Description
1	AI 0	I	AI0: Analog input AI 0
2	AI 1	I	AI1: Analog input AI 1
3	Analog 0V	I	4M: GND for analog inputs
4	DI 0	I	+0.0: Digital input DI 0 / Counter 0 (A) *
5	DI 1	I	+0.1: Digital input DI 1 / Counter 0 (B) / Frequency 0 *
6	DI 2	I	+0.2: Digital input DI 2
7	DI 3	I	+0.3: Digital input DI 3 / Counter 1 (A) *
8	DI 4	I	+0.4: Digital input DI 4 / Counter 1 (B) / Frequency 1 *
9	DI 5	I	+0.5: Digital input DI 5
10	DI 6	I	+0.6: Digital input DI 6 / Counter 2 (A) *
11	DI 7	I	+0.7: Digital input DI 7 / Counter 2 (B) / Frequency 2 *
12	DI 8	I	+1.0: Digital input DI 8
13	DI 9	I	+1.1: Digital input DI 9 / Counter 3 (A) *
14	DI 10	I	+1.2: Digital input DI 10 / Counter 3 (B) / Frequency 3 *
15	DI 11	I	+1.3: Digital input DI 11 / Gate 3 *
16	DI 12	I	+1.4: Digital input DI 12
17	DI 13	I	+1.5: Digital input DI 13
18	DI 14	I	+1.6: Digital input DI 14
19	DI 15	I	+1.7: Digital input DI 15 / Latch 3 *
20	DC 24V	I	5L+: DC 24V for onboard DI power section supply
21	0 V	I	5M: GND for onboard DI power section supply

*) Max. input frequency 100kHz otherwise 1kHz.

5.4.3 Parametrization

5.4.3.1 Address assignment

Sub module	Input address	Access	Assignment
DI24/DO16	136	BYTE	Digital input I+0.0 ... I+0.7 (X4)
	137	BYTE	Digital input I+1.0 ... I+1.7 (X4)

5.4.3.2 Hardware interrupt

Parameter hardware configuration

With the parameter *'Hardware interrupt at ...'* you can specify a hardware interrupt for each input for the corresponding edge. The hardware interrupt is disabled, if nothing is selected (default setting). A diagnostics interrupt is only supported with *Hardware interrupt lost*. Select with the arrow keys the input and enable the according hardware interrupts.

Here is valid:

- Rising edge: Edge 0-1
- Falling edge: Edge 1-0

5.4.3.3 Input delay

Parameter hardware configuration

- The input delay can be configured per channel in groups of 4.
- An input delay of 0.1ms is only possible with "fast" inputs, which have a max. input frequency of 100kHz ↪ *'X4: Connector' on page 130*. Within a group, the input delay for slow inputs is limited to 0.5ms.
- Range of values: 0.1ms / 0.5ms / 3ms / 15ms

5.4.4 Status indication

Digital input	LED ■ green	Description
DI +0.0 DI +0.7	●	Digital I+0.0 ... 0.7 has "1" signal
	○	Digital I+0.0 ... 0.7 has "0" signal
DI +1.0 ... DI +1.7	●	Digital I+1.0 ... 1.7 has "1" signal
	○	Digital input I+1.0 ... 1.7 has "0" signal

Power supply	LED ■ green	Description
1L+	●	DC 24V electronic section supply
	○	DC 24V electronic section supply not available
2L+	●	DC 24V power section supply outputs OK
	○	DC 24V power section supply outputs OK
3L+	●	DC 24V power section supply SLIO bus OK
	○	DC 24V power section supply SLIO bus not available
5L+	●	DC 24V power section supply inputs OK
	○	DC 24V power section supply inputs not available

Error	LED ■ red	Description
1F	●	Error power supply sensor
	○	No error
2F	●	Error at overload respectively short circuit at the outputs
	○	No error

on: ● | off: ○

5.5 Digital output

5.5.1 Properties

- 12xDC 24V, 0.5A
- Status indication via LEDs

5.5.2 Wiring

X5: Connector

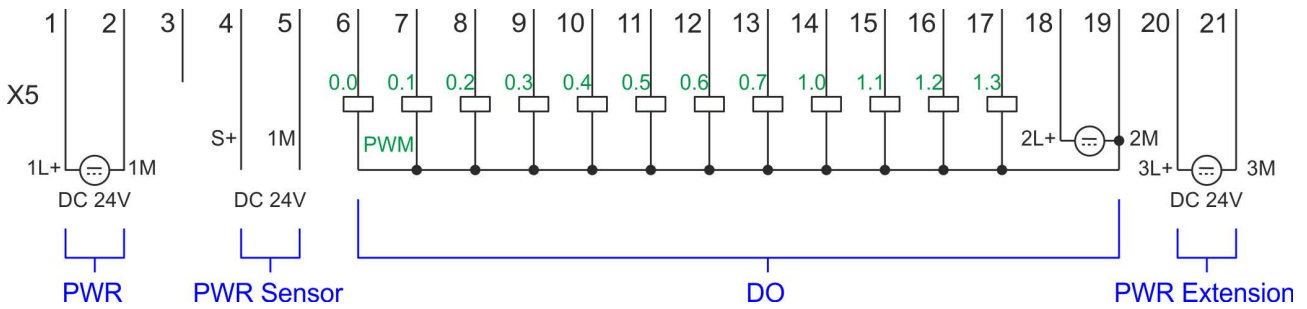

Pos.	Function	Type	Description
1	Sys DC 24V	I	1L+: DC 24V for electronic section supply
2	Sys 0V	I	1M: GND for electronic section supply
3	---	---	reserved
4	DC 24V	O	S+: DC 24V for sensor
5	0V	O	1M: GND for sensor
6	DO 0	O	+0.0: Digital output DO 0 / PWM 0 / Output channel counter 0
7	DO 1	O	+0.1: Digital output DO 1 / PWM 1 / Output channel counter 1
8	DO 2	O	+0.2: Digital output DO 2 / Output channel counter 2
9	DO 3	O	+0.3: Digital output DO 3 / Output channel counter 3
10	DO 4	O	+0.4: Digital output DO 4
11	DO 5	O	+0.5: Digital output DO 5
12	DO 6	O	+0.6: Digital output DO 6
13	DO 7	O	+0.7: Digital output DO 7
14	DO 8	O	+1.0: Digital output DO 8
15	DO 9	O	+1.1: Digital output DO 9
16	DO 10	O	+1.2: Digital output DO 10
17	DO 11	O	+1.3: Digital output DO 11
18	DC 24V	I	2L+: DC 24V for onboard DO power section supply
19	0 V	I	2M: GND for onboard DO power section supply / GND PWM
20	DC 24V	I	3L+: DC 24V for SLIO bus power section supply
21	0 V	I	3M: GND for SLIO bus power section supply

5.5.3 Parametrization

5.5.3.1 Address assignment

Sub module	Output address	Access	Assignment
DI24/DO16	136	BYTE	Digital output Q+0.0 ... Q+0.7 (X5)
	137	BYTE	Digital output Q+1.0 ... Q+1.3 (X5)

5.5.4 Status indication

Digital output	LED  green	Description
DO +0.0 ... DO +0.7	●	Digital output Q+0.0 ... 0.7 has "1" signal
	○	Digital output Q+0.0 ... 0.7 has "0" signal
DO +1.0 ... DO +1.3	●	Digital output Q+1.0 ... 1.3 has "1" signal
	○	Digital output Q+1.0 ... 1.3 has "0" signal

Power supply	LED  green	Description
1L+	●	DC 24V electronic section supply
	○	DC 24V electronic section supply not available
2L+	●	DC 24V power section supply outputs OK
	○	DC 24V power section supply outputs OK
3L+	●	DC 24V power section supply SLIO bus OK
	○	DC 24V power section supply SLIO bus not available
5L+	●	DC 24V power section supply inputs OK
	○	DC 24V power section supply inputs not available

Error	LED  red	Description
1F	●	Error power supply sensor
	○	no error
2F	●	Error at overload respectively short circuit at the outputs
	○	no error

on: ● | off: ○

Counting > Properties

5.6 Counting

5.6.1 Properties

- 4 channels
- Various counting modes
 - once
 - continuously
 - periodically
- Control by the user program via blocks

5.6.2 Wiring

5.6.2.1 Counter inputs

X4: Connector

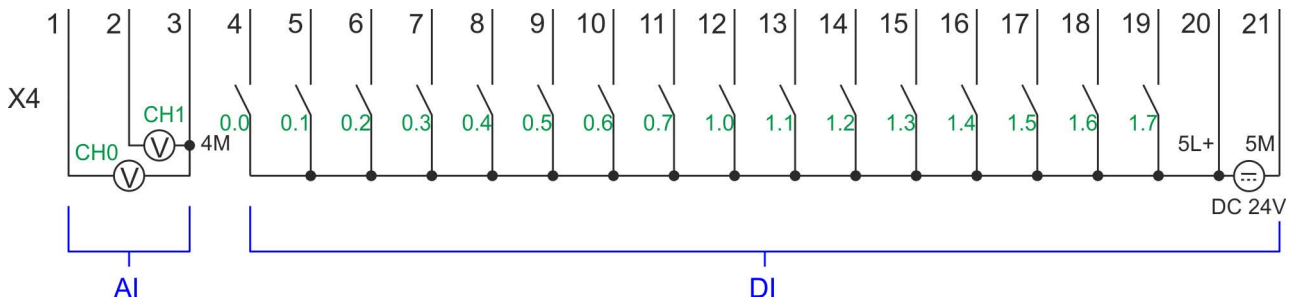

Pos.	Function	Type	Description
1	AI 0	I	AI0: Analog input AI 0
2	AI 1	I	AI1: Analog input AI 1
3	Analog 0V	I	4M: GND for analog inputs
4	DI 0	I	+0.0: Digital input DI 0 / Counter 0 (A) *
5	DI 1	I	+0.1: Digital input DI 1 / Counter 0 (B) / Frequency 0 *
6	DI 2	I	+0.2: Digital input DI 2
7	DI 3	I	+0.3: Digital input DI 3 / Counter 1 (A) *
8	DI 4	I	+0.4: Digital input DI 4 / Counter 1 (B) / Frequency 1 *
9	DI 5	I	+0.5: Digital input DI 5
10	DI 6	I	+0.6: Digital input DI 6 / Counter 2 (A) *
11	DI 7	I	+0.7: Digital input DI 7 / Counter 2 (B) / Frequency 2 *
12	DI 8	I	+1.0: Digital input DI 8
13	DI 9	I	+1.1: Digital input DI 9 / Counter 3 (A) *
14	DI 10	I	+1.2: Digital input DI 10 / Counter 3 (B) / Frequency 3 *
15	DI 11	I	+1.3: Digital input DI 11 / Gate 3 *
16	DI 12	I	+1.4: Digital input DI 12
17	DI 13	I	+1.5: Digital input DI 13
18	DI 14	I	+1.6: Digital input DI 14
19	DI 15	I	+1.7: Digital input DI 15 / Latch 3 *
20	DC 24V	I	5L+: DC 24V for onboard DI power section supply
21	0 V	I	5M: GND for onboard DI power section supply

*) Max. input frequency 100kHz otherwise 1kHz.

Input signals

The following sensors can be connected

- 24V incremental encoders with two phase-shifted by 90 ° tracks
- 24V pulse encoder with direction signal
- 24V initiator as BERU or beam sensor

For not all inputs are available at the same time, for every counter you may define the input assignment via the parameterization for the following input signals:

- *Counter_x (A)*
 - Pulse input for counter signal respectively track A of an encoder for 1-, 2- or 4-fold evaluation.
- *Counter_x (B)*
 - Direction signal respectively track B of the encoder. Via the parameterization you may invert the direction signal.
- *Gate 3*
 - Via this input you can if parameterized open the HW gate of *Counter 3* with edge 0-1 and start counting.
- *Latch 3*
 - Via this input via edge 0-1 the current counter value of *Counter 3* is stored in a memory that you may read if needed.

5.6.2.2 Counter outputs

X5: Connector

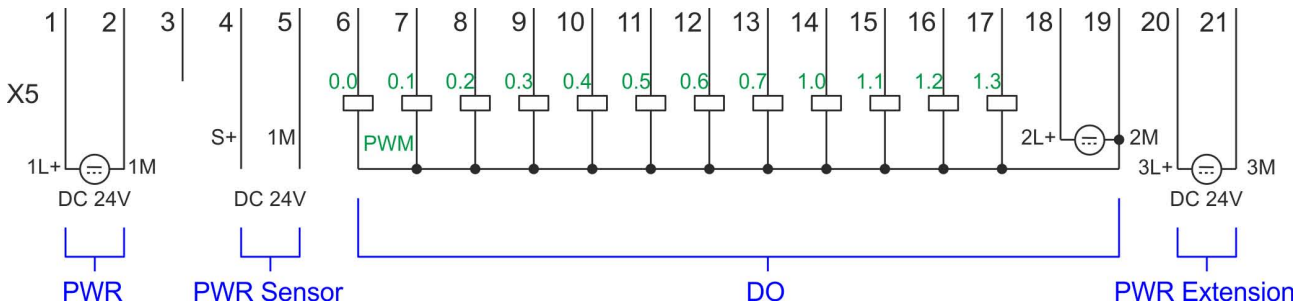

Pos.	Function	Type	Description
1	Sys DC 24V	I	1L+: DC 24V for electronic section supply
2	Sys 0V	I	1M: GND for electronic section supply
3	---	---	reserved
4	DC 24V	O	S+: DC 24V for sensor
5	0V	O	1M: GND for sensor
6	DO 0	O	+0.0: Digital output DO 0 / PWM 0 / Output channel counter 0
7	DO 1	O	+0.1: Digital output DO 1 / PWM 1 / Output channel counter 1
8	DO 2	O	+0.2: Digital output DO 2 / Output channel counter 2
9	DO 3	O	+0.3: Digital output DO 3 / Output channel counter 3
10	DO 4	O	+0.4: Digital output DO 4
11	DO 5	O	+0.5: Digital output DO 5
12	DO 6	O	+0.6: Digital output DO 6
13	DO 7	O	+0.7: Digital output DO 7
14	DO 8	O	+1.0: Digital output DO 8
15	DO 9	O	+1.1: Digital output DO 9
16	DO 10	O	+1.2: Digital output DO 10
17	DO 11	O	+1.3: Digital output DO 11
18	DC 24V	I	2L+: DC 24V for onboard DO power section supply
19	0 V	I	2M: GND for onboard DO power section supply / GND PWM
20	DC 24V	I	3L+: DC 24V for SLIO bus power section supply
21	0 V	I	3M: GND for SLIO bus power section supply

Output channel Counter_x

Every counter has an assigned output channel. For each counter you can specify the behavior of the counter output via the parametrization with 'Characteristics of the output' and 'Pulse duration'. ↪ 'Parameter overview' on page 149

5.6.3 Proceeding

Hardware configuration

In the Siemens SIMATIC Manager the following steps should be executed:

1. ▶ Perform a hardware configuration for the CPU. ↪ *'Hardware configuration - CPU'* on page 61
2. ▶ Double-click the counter sub module of the CPU 314C-2 PN/DP.
⇒ The dialog *'Properties'* is opened.
3. ▶ As soon as you select the operating mode for the corresponding channel, a dialog box with default values for this counter mode is created and shown. ↪ *'Counter operating modes'* on page 153
4. ▶ Perform the required parameter settings.
5. ▶ Save your project with *'Station → Safe and compile'*.
6. ▶ Transfer your project to your CPU.

User program



You must not call an SFB you have configured in your program in another program section under another priority class, because the SFB must not interrupt itself. Example: It is not allowed to call the same SFB both in OB 1 and in the interrupt OB.

- The ↪ *'SFB 47 - COUNT - Counter controlling'* on page 142 should cyclically be called (e.g. OB 1) for controlling the counter functions.
- The SFB is to be called with the corresponding instance DB. Here the parameters of the SFB are stored.
- Among others the ↪ *'SFB 47 - COUNT - Counter controlling'* on page 142 contains a request interface. Hereby you get read and write access to the registers of the appropriate counter.
- So that a new job may be executed, the previous job must have been finished with `JOB_DONE = TRUE`.
- Per channel you may call the SFB in each case with the same instance DB, since the data necessary for the internal operational are stored here.
- Writing accesses to outputs of the instance DB is not permissible.
- Starting, stopping and interrupting a count function of *Counter 0* to *Counter 2* exclusively happens via the SW gate by setting the SW gate of ↪ *'SFB 47 - COUNT - Counter controlling'* on page 142. You can also activate input *'Gate 3'* via the parametrization for *Counter 3*.

5.6.4 SFB 47 - COUNT - Counter controlling

Description

The SFB 47 is a specially developed block for compact CPUs for controlling of the counters. The SFB is to be called with the corresponding instance DB. Here the parameters of the SFB are stored. With the SFB COUNT (SFB 47) you have following functional options:

- Start/Stop the counter via software gate `SW_GATE`
- Enable/control digital output DO
- Read the status bit

- Read the actual count and latch value
- Request to read/write internal counter registers

Parameters

Name	Data type	Address (Instance DB)	Default value	Comment
LADDR	WORD	0.0	300h	This parameter is not evaluated. Always the internal I/O periphery is addressed.
CHANNEL	INT	2.0	0	Channel number
SW_GATE	BOOL	4.0	FALSE	Enables the Software gate
CTRL_DO	BOOL	4.1	FALSE	Enables the output False: Standard Digital Output
SET_DO	BOOL	4.2	FALSE	Parameter is not evaluated
JOB_REQ	BOOL	4.3	FALSE	Initiates the job (edge 0-1)
JOB_ID	WORD	6.0	0	Job ID
JOB_VAL	DINT	8.0	0	Value for write jobs
STS_GATE	BOOL	12.0	FALSE	Status of the internal gate
STS_STRT	BOOL	12.1	FALSE	Status of the hardware gate
STS_LTCH	BOOL	12.2	FALSE	Status of the latch input
STS_DO	BOOL	12.3	FALSE	Status of the output
STS_C_DN	BOOL	12.4	FALSE	Status of the down-count Always indicates the last direction of count. After the first SFB call <i>STS_C_DN</i> is set FALSE.
STS_C_UP	BOOL	12.5	FALSE	Status of the up-count Always indicates the last direction of count. After the first SFB call <i>STS_C_UP</i> is set TRUE.
COUNTVAL	DINT	14.0	0	Actual count value
LATCHVAL	DINT	18.0	0	Actual latch value
JOB_DONE	BOOL	22.0	TRUE	New job can be started
JOB_ERR	BOOL	22.1	FALSE	Job error
JOB_STAT	WORD	24.0	0	Job error ID

Local data only in instance DB

Name	Data type	Address (Instance DB)	Default value	Comment
RES00	BOOL	26.0	FALSE	reserved
RES01	BOOL	26.1	FALSE	reserved
RES02	BOOL	26.2	FALSE	reserved
STS_CMP	BOOL	26.3	FALSE	Comparator Status * Status bit <i>STS_CMP</i> indicates that the comparison condition of the comparator is or was reached. <i>STS_CMP</i> also indicates that the output was set. (<i>STS_DO</i> = TRUE).
RES04	BOOL	26.4	FALSE	reserved
STS_OFLW	BOOL	26.5	FALSE	Overflow status *
STS_UFLW	BOOL	26.6	FALSE	Underflow status *
STS_ZP	BOOL	26.7	FALSE	Status of the zero mark * The bit is only set when counting without main direction. Indicates the zero mark. This is also set when the counter is set to 0 or if it starts counting.
JOB_OVAL	DINT	28.0		Output value for read request.
RES10	BOOL	32.0	FALSE	reserved
RES11	BOOL	32.1	FALSE	reserved
RES_STS	BOOL	32.2	FALSE	Reset status bits: Resets the status bits: <i>STS_CMP</i> , <i>STS_OFLW</i> , <i>STS_ZP</i> . The SFB must be twice called to reset the status bit.

*) Reset with RES_STS



Per channel you may call the SFB in each case with the same instance DB, since the data necessary for the internal operations are stored here. Writing accesses to outputs of the instance DB is not permissible.

Counter request interface

To read/write counter registers the request interface of the SFB 47 may be used. So that a new job may be executed, the previous job must have been finished with *JOB_DONE* = TRUE.

Proceeding

The deployment of the request interface takes place at the following sequence:

1. ▶ Edit the following input parameters:

Name	Data type	Address (DB)	Default	Comment
JOB_REQ	BOOL	4.3	FALSE	Initiates the job (edges 0-1) *
JOB_ID	WORD	6.0	0	Job ID: 00h Job without function 01h Writes the <i>count value</i> 02h Writes the <i>load value</i> 04h Writes the <i>comparison value</i> 08h Writes the <i>hysteresis</i> 10h Writes the <i>pulse duration</i> 20h Writes the <i>end value</i> 82h Reads the <i>load value</i> 84h Reads the <i>comparison value</i> 88h Reads the <i>hysteresis</i> 90h Reads the <i>pulse duration</i> A0h Reads the <i>end value</i>
JOB_VAL	DINT	8.0	0	Value for write jobs

*) State remains set also after a CPU STOP-RUN transition.

2. Call the SFB. The job is processed immediately. *JOB_DONE* only applies to SFB run with the result FALSE. *JOB_ERR* = TRUE if an error occurred. Details on the error cause are indicated at *JOB_STAT*.

Name	Data type	Address (DB)	Default	Comment
JOB_DONE	BOOL	22.0	TRUE	New job can be started
JOB_ERR	BOOL	22.1	FALSE	Job error
JOB_STAT	WORD	24.0	0000h	Job error ID 0000h No error 0121h <i>Comparison value</i> too low 0122h <i>Comparison value</i> too high 0131h <i>Hysteresis</i> too low 0132h <i>Hysteresis</i> too high 0141h <i>Pulse duration</i> too low 0142h <i>Pulse duration</i> too high 0151h <i>Load value</i> too low 0152h <i>Load value</i> too high 0161h <i>Count value</i> too low 0162h <i>Count value</i> too high 01FFh Invalid <i>job ID</i>

3. A new job may be started with *JOB_DONE* = TRUE.
4. A value to be read of a read job may be found in *JOB_OVAL* in the instance DB at address 28.

Permitted value range for JOB_VAL

Continuous count:

Job	Valid range
Writing <i>counter</i> directly	-2147483647 ($-2^{31}+1$) ... +2147483646 ($2^{31}-2$)
Writing the <i>load value</i>	-2147483647 ($-2^{31}+1$) ... +2147483646 ($2^{31}-2$)
Writing <i>comparison value</i>	-2147483648 (-2^{31}) ... +2147483647 ($2^{31}-1$)
Writing <i>hysteresis</i>	0 ... 255
Writing <i>pulse duration</i> *	0 ... 510ms

Single/periodic count, no main count direction:

Job	Valid range
Writing <i>counter</i> directly	-2147483647 ($-2^{31}+1$) ... +2147483646 ($2^{31}-2$)
Writing the <i>load value</i>	-2147483647 ($-2^{31}+1$) ... +2147483646 ($2^{31}-2$)

Job	Valid range
Writing <i>comparison value</i>	-2147483648 (-2^{31}) ... +2147483647 ($2^{31}-1$)
Writing <i>hysteresis</i>	0 ... 255
Writing <i>pulse duration*</i>	0 ... 510ms

Single/periodic count, main count direction up:

Job	Valid range
<i>End value</i>	2 ... +2147483646 ($2^{31}-1$)
Writing <i>counter directly</i>	-2147483648 (-2^{31}) ... <i>end value</i> -2
Writing the <i>load value</i>	-2147483648 (-2^{31}) ... <i>end value</i> -2
Writing <i>comparison value</i>	-2147483648 (-2^{31}) ... <i>end value</i> -1
Writing <i>hysteresis</i>	0 ... 255
Writing <i>pulse duration*</i>	0 ... 510ms

Single/periodic count, main count direction down:

Job	Valid range
Writing <i>counter directly</i>	2 ... +2147483647 ($2^{31}-1$)
Writing the <i>load value</i>	2 ... +2147483647 ($2^{31}-1$)
Writing <i>comparison value</i>	1 ... +2147483647 ($2^{31}-1$)
Writing <i>hysteresis</i>	0 ... 255
Writing <i>pulse duration*</i>	0 ... 510ms

*) Only even values allowed. Odd values are automatically rounded.

Latch function

As soon as during a count process an edge 0-1 is recognized at the "Latch" input of a counter, the recent counter value is stored in the according latch register.

You may access the latch register via *LATCHVAL* of the SFB 47.

A just in *LATCHVAL* loaded value remains after a STOP-RUN transition.

5.6.5 Parametrization

5.6.5.1 Address assignment

Sub module	Input address	Access	Assignment
Counter	816	DINT	Channel 0: Counter value / Frequency value
	820	DINT	Channel 1: Counter value / Frequency value
	824	DINT	Channel 2: Counter value / Frequency value
	828	DINT	Channel 3: Counter value / Frequency value

Sub module	Output address	Access	Assignment
Counter	816	DWORD	reserved
	820	DWORD	reserved
	824	DWORD	reserved
	828	DWORD	reserved

5.6.5.2 Interrupt selection

Via *'Basic parameters'* you can reach *'Select interrupt'*. Here you can define the interrupts the CPU will trigger. The following parameters are supported:

- None: The interrupt function is disabled.
- Process: The following events of the counter can trigger a hardware interrupt (selectable via *'Count'*):
 - Hardware gate opening
 - Hardware gate closing
 - On reaching the comparator
 - on Counting pulse
 - on overflow
 - on underflow
- Diagnostics+process: A diagnostics interrupt is only triggered when a hardware interrupt was lost.

5.6.5.3 Operating mode per channel

Parameter hardware configuration

Select via *'Channel'* the channel select via *'Operating'* the operating mode. The following operating modes are supported:

- Not parameterized: Channel is deactivated
- ↪ *'Count continuously'* on page 153
- ↪ *'Count once'* on page 154
- ↪ *'Count Periodically'* on page 157
- ↪ *'Frequency measurement'* on page 167
- ↪ *'Pulse width modulation - PWM'* on page 176

Depending on the selected operating mode default values are loaded and shown in an additional register.

5.6.5.4 Counter

Parameter hardware configuration

Default values and structure of this dialog box depend on the selected 'Operating mode'.

Parameter overview

Operating parameters	Description	Assignment
Main count direction	<ul style="list-style-type: none"> ■ <i>None</i> No restriction of the counting range ■ <i>Up</i>: Restricts the up-counting range. The counter starts from 0 or <i>load value</i>, counts in positive direction up to the declaration <i>end value</i> -1 and then jumps back to <i>load value</i> at the next positive transducer pulse. ■ <i>Down</i>: Restricts the down-counting range. The counter starts from the declared <i>start value</i> or <i>load value</i> in negative direction, counts to 1 and then jumps to <i>start value</i> at the next negative encoder pulse. Function is disable with <i>count continuously</i>. 	<ul style="list-style-type: none"> ■ None
Gate function	<ul style="list-style-type: none"> ■ <i>Cancel count</i>: The count starts when the gate opens and resumes at the <i>load value</i> when the gate opens again. ■ <i>Stop count</i>: The count is interrupted when the gate closes and resumed at the last actual counter value when the gate opens again. <p>🔗 'Gate function' on page 160</p>	Abort count process
Start value End value	<p><i>Start value</i> with counting direction backward. <i>End value</i> with main counting direction forward. Range of values: 2...2147483647 ($2^{31}-1$)</p>	2147483647 ($2^{31}-1$)
Comparison value	<p>The count value is compared with the <i>comparison value</i>. See also the parameter "Characteristics of the output":</p> <ul style="list-style-type: none"> ■ No main counting direction <ul style="list-style-type: none"> – Range of values: -2^{31} to $+2^{31}-1$ ■ Main counting direction forward <ul style="list-style-type: none"> – Range of values: -2^{31} to end value-1 ■ Main counting direction backward <ul style="list-style-type: none"> – Range of values: 1 to $+2^{31}-1$ 	0
Hysteresis	<p>The <i>hysteresis</i> serves the avoidance of many toggle processes of the output, if the counter value is in the range of the <i>comparison value</i>.</p> <p>0, 1: <i>Hysteresis</i> disabled Range of values: 0 to 255</p>	0

Input	Description	Assignment
Signal evaluation	Specify the signal of the connected encoder: <ul style="list-style-type: none"> ■ Pulse/direction At the input count and direction signal are connected ■ At the input there is an encoder connected with the following evaluation: <ul style="list-style-type: none"> – Rotary encoder single – Rotary encoder double – Rotary encoder quadruple 	Pulse/direction
Hardware gate	Gate control exclusively via channel 3: <ul style="list-style-type: none"> ■ enabled: The gate control for channel 3 happens via SW and HW gate ■ disabled: The gate control for channel 3 exclusively happens via SW gate ↗ <i>'Gate function' on page 160</i>	disabled
Count direction inverted	Invert the input signal <i>'Direction'</i> : <ul style="list-style-type: none"> ■ enabled: The input signal is inverted ■ disabled: The input signal is not inverted 	disabled

Output	Description	Assignment
Characteristics of the output	<p>The output and the "Comparator" (STS_CMP) status bit are set, dependent on this parameter.</p> <ul style="list-style-type: none"> ■ No comparison: The output is used as normal output and STS_CMP remains reset. ■ Comparator <ul style="list-style-type: none"> – Counter value \geq Comparison value – Counter value \leq Comparison value ■ Pulse at <i>comparison value</i> <ul style="list-style-type: none"> – To adapt the used actuators you can specify a <i>pulse duration</i>. The output is set for the specified <i>pulse duration</i> when the counter value reaches the <i>comparison value</i>. When you've set a main counting direction the output is only set at reaching the <i>comparison value</i> from the main counting direction. 	No comparison
Pulse duration	<p>Here you can specify the <i>pulse duration</i> for the output signal.</p> <ul style="list-style-type: none"> ■ The <i>pulse duration</i> starts with the setting of the according digital output. ■ The inaccuracy of the <i>pulse duration</i> is less than 1ms. ■ There is no past triggering of the <i>pulse duration</i> when the <i>comparison value</i> has been left and reached again during pulse output. ■ If the <i>pulse duration</i> is changed during operation, it will take effect with the next pulse. ■ If the <i>pulse duration</i> = 0, the output is set until the comparison condition is not longer fulfilled. <p>Range of values: 0...510ms in steps of 2ms</p>	0
Hardware interrupt	Description	Assignment
Hardware gate opening	<p>Hardware interrupt by edge 0-1 exclusively at HW gate channel 3</p> <ul style="list-style-type: none"> ■ enabled: Process interrupt by edge 0-1 exclusively at HW gate channel 3 with open SW gate ■ disabled: no hardware interrupt 	disabled
Hardware gate closing	<p>Hardware interrupt by edge 1-0 exclusively at HW gate channel 3</p> <ul style="list-style-type: none"> ■ enabled: Process interrupt by edge 1-0 exclusively at HW gate channel 3 with open SW gate ■ disabled: no hardware interrupt 	disabled
On reaching comparator	<p>Hardware interrupt on reaching <i>comparator</i></p> <ul style="list-style-type: none"> ■ enabled: Hardware interrupt when comparator is triggered, can be configured via '<i>Characteristics of the output</i>' ■ disabled: no hardware interrupt 	disabled

Hardware interrupt	Description	Assignment
Overflow	Hardware interrupt overflow <ul style="list-style-type: none"> ■ enabled: Hardware interrupt on overflow the upper counter limit ■ disabled: no hardware interrupt 	disabled
Underflow	Hardware interrupt on underrun <ul style="list-style-type: none"> ■ enabled: Hardware interrupt on underflow the lower counter limit ■ disabled: no hardware interrupt 	disabled
Max. frequency	Description	Assignment
Counting signals/HW gate	Specify the max. frequency for track A/pulse, track B/direction and HW gate Range of values: 1, 2, 5, 10, 30, 60kHz	60kHz
Latch	Specify the max. frequency for the latch signal Range of values: 1, 2, 5, 10, 30, 60kHz	10kHz

5.6.6 Counter operating modes

5.6.6.1 Count continuously

- In this operating mode the counter counts starting with the *load value*.
- When the counter counts forward and reaches the upper count limit and another counting pulse in positive direction arrives, it jumps to the lower count limit and counts from there on.
- When the counter counts backwards and reaches the lower count limit and another counting pulse in negative direction arrives, it jumps to the upper count limit and counts from there on.
- The counter limits are fix set to maximum range.
- With overflow or underflow the status bits STS_OFLW respectively STS_UFLW are set \leftrightarrow 'SFB 47 - COUNT - Counter controlling' on page 142. These bits remain set until these are reset with RES_STS. If enabled additionally a hardware interrupt is triggered.

Limits	Valid range of values
Lower count limit	-2 147 483 648 (-2^{31})
Upper count limit	+2 147 483 647 ($2^{31} - 1$)

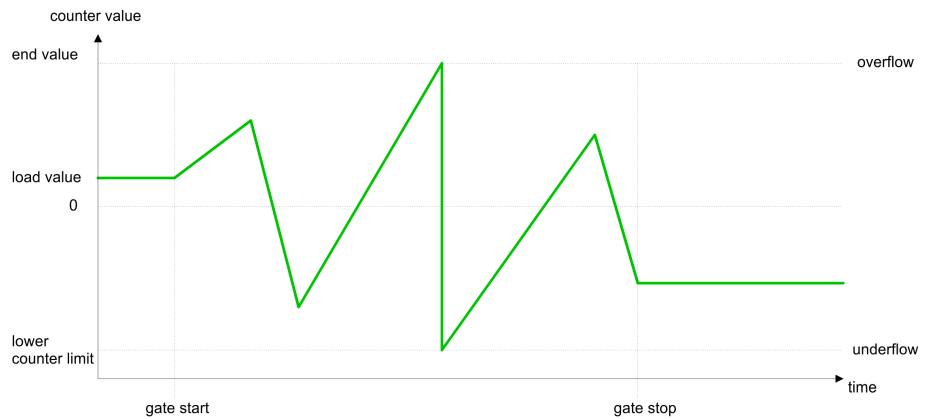

5.6.6.2 Count once

5.6.6.2.1 No main counting direction

- The counter counts once starting with *load value*.
- It is counted forward or backward.
- The counter limits are fix set to maximum range.
- At over- or underflow at the count limits, the counter jumps to the according other count limit and the gate is automatically closed.
- To restart the count process, you have to generate an edge 0-1 at the gate ↪ ‘Gate function’ on page 160.
- With the configured ‘Gate function’ ‘Interrupt count’ the counting is continued with current *Counter value*.
- With configured ‘Gate function’ ‘Cancel count’ the counter starts with the *Load value*.

Limits	Valid range of values
Lower count limit	-2 147 483 648 (-2^{31})
Upper count limit	+2 147 483 647 ($2^{31} - 1$)

Interrupting gate control



Aborting gate control



5.6.6.2.2 Main counting direction forward

- The counter counts forward starting with the *load value*.
- When the counter reaches the *End value* -1 in positive direction, it jumps to the *load value* at the next count pulse and the gate is automatically closed. If enabled additionally a hardware interrupt is triggered.
- To restart the count process, you have to generate an edge 0-1 at the gate *Gate function* on page 160. The counter counts starting with the *load value*.
- You may exceed the lower count limit.

Limits	Valid range of values
End value	-2 147 483 647 ($-2^{31} + 1$) up to +2 147 483 647 ($2^{31} - 1$)
Lower count limit	-2 147 483 648 (-2^{31})

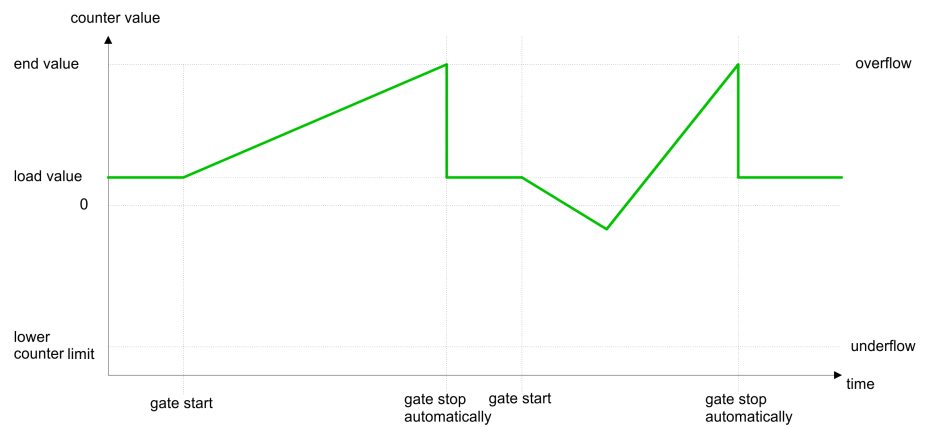

5.6.6.2.3 Main counting direction backward

- The counter counts backward starting with the *load value*.
- When the counter reaches the *End value* +1 in positive direction, it jumps to the *load value* at the next count pulse and the gate is automatically closed. If enabled additionally a hardware interrupt is triggered.
- To restart the count process, you have to generate an edge 0-1 at the gate *Gate function* on page 160. The counter counts starting with the *load value*.
- You may exceed the upper count limit.

Limits	Valid range of values
End value	-2 147 483 648 (-2^{31}) up to +2 147 483 646 ($2^{31} - 2$)
Upper count limit	+2 147 483 647 ($2^{31} - 1$)

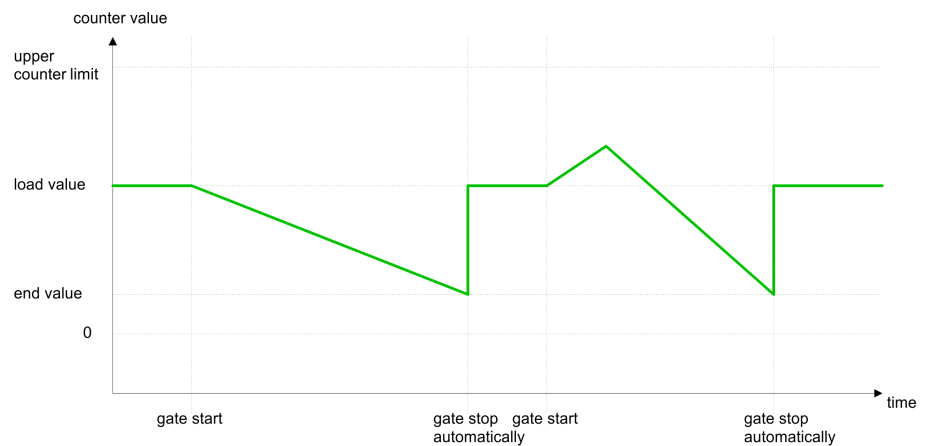

5.6.6.3 Count Periodically

5.6.6.3.1 No main counting direction

- The counter counts forward or backwards starting with the *load value*.
- At over- or underrun at the count limits, the counter jumps to the *load value* and continues counting. If enabled additionally a hardware interrupt is triggered.
- The counter limits are fix set to maximum range.

Limits	Valid range of values
Lower count limit	-2 147 483 648 (-2^{31})
Upper count limit	+2 147 483 647 ($2^{31} - 1$)



5.6.6.3.2 Main counting direction forward

- The counter counts forward starting with the *load value*.
- When the counter reaches the end value -1 in positive direction, it jumps to the *load value* at the next positive count pulse and continues counting. If enabled additionally a hardware interrupt is triggered.
- You may exceed the lower count limit.

Limits	Valid range of values
End value	-2 147 483 647 ($-2^{31} + 1$) up to +2 147 483 647 ($2^{31} - 1$)
Lower count limit	-2 147 483 648 (-2^{31})

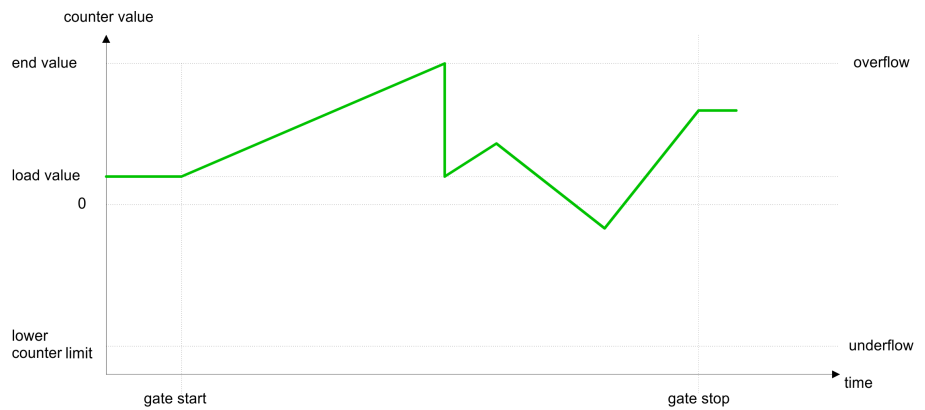

5.6.6.3.3 Main counting direction backward

Main counting direction backward

- The counter counts backward starting with the *load value*.
- When the counter reaches the *end value* +1 in positive direction, it jumps to the *load value* at the next negative count pulse and continues counting. If enabled additionally a hardware interrupt is triggered.
- You may exceed the upper count limit.

Limits	Valid range of values
End value	-2 147 483 648 (-2^{31}) up to +2 147 483 646 ($2^{31} - 2$)
Upper count limit	+2 147 483 647 ($2^{31} - 1$)

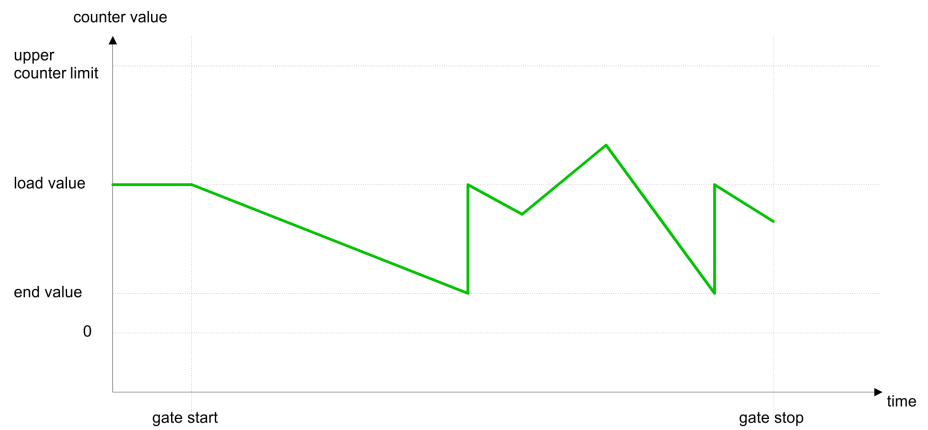

5.6.7 Counter - Additional functions

5.6.7.1 Overview

Schematic structure

The illustration shows how the additional functions influence the counting behavior. The following pages describe these additional functions in detail:

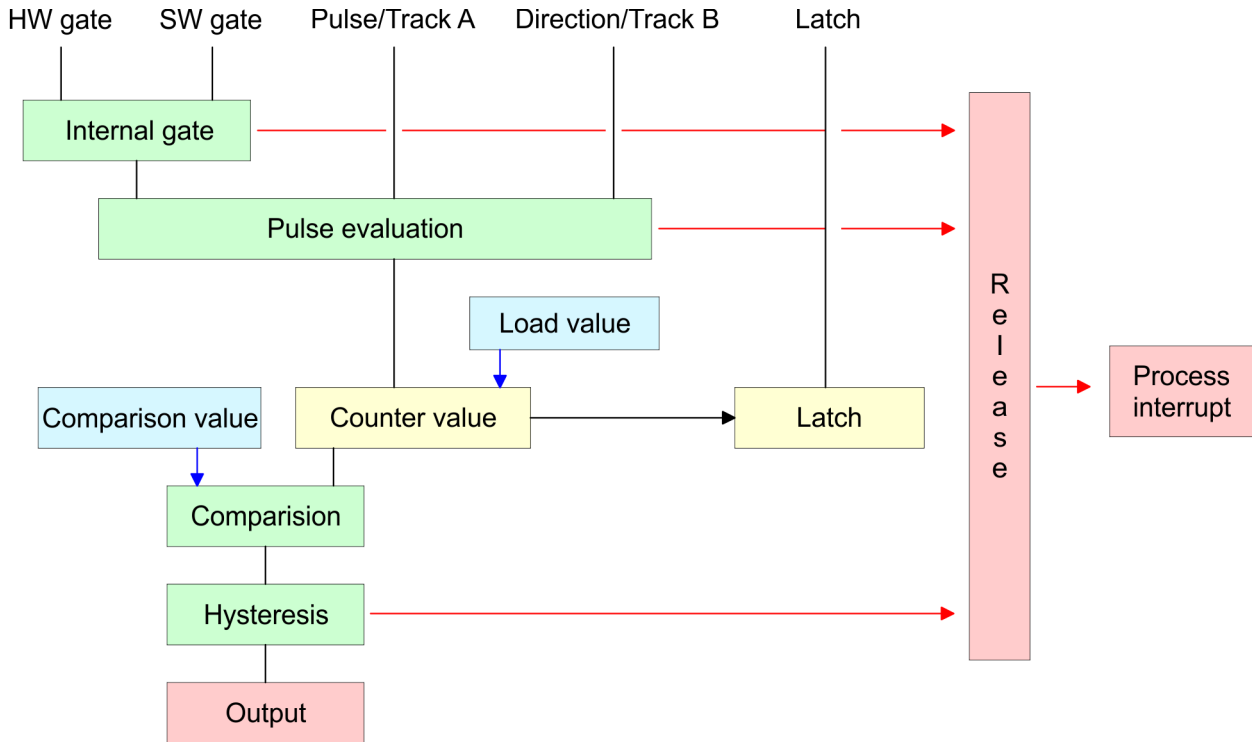

5.6.7.2 Gate function

Function

- Starting, stopping and interrupting a count function of *counter 0* to *counter 2* exclusively happens via the SW gate by setting the SW gate of ↗ 'SFB 47 - COUNT - Counter controlling' on page 142.
- Starting, stopping and interrupting a count function of *counter 3* happens via the internal gate (I gate). The i gate is the result of logic operation of HW gate and SW gate. The HW gate evaluation of the connection 'Gate 3' may be deactivated by the parametrization. With a de-activated HW gate evaluation the triggering exclusively happens by setting the SW gate of ↗ 'SFB 47 - COUNT - Counter controlling' on page 142.

Gate function abort and interrupt

The parametrization defines if the gate interrupts or aborts the counter process.

- At *abort function* the counter starts counting with the *load value* after gate restart.

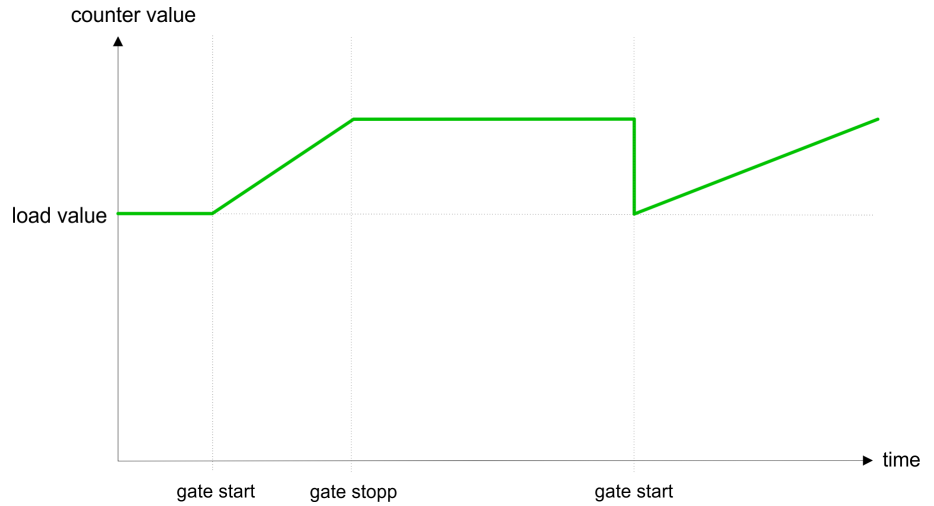

- At *interrupt function*, the counter starts counting with the last recent counter value after gate restart.

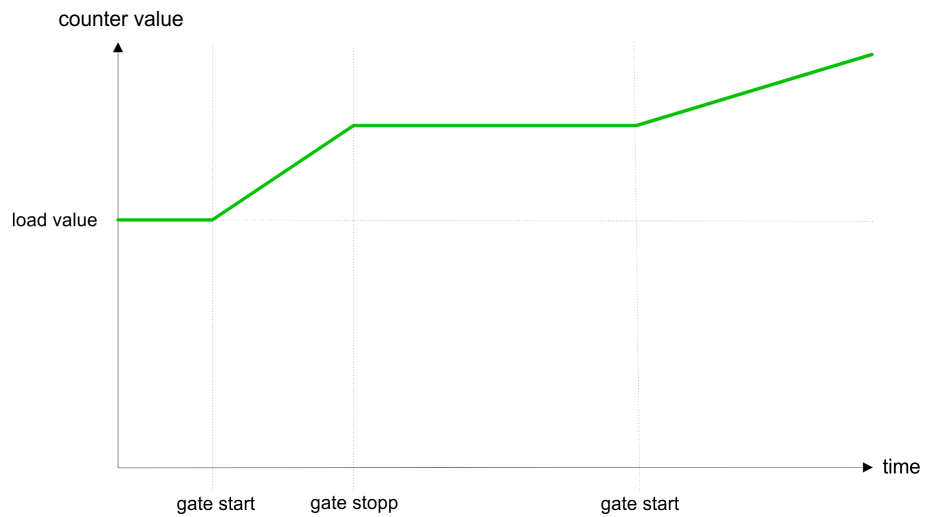

Counter 0 ... 2

SW gate	Gate function	Reaction counter 0 ... 2
Edge 0-1	Abort count process	Restart with <i>load value</i>
Edge 0-1	Interrupt count process	Continue

5.6.7.3 Comparator

Function

In the CPU a *comparison value* may be stored. During the counting procedure the counter value is compared with the *comparative value*. Depending on the result of the comparison the output channel of the counter and the status bit of STS_CMP of ↗ 'SFB 47 - COUNT - Counter controlling' on page 142 can be set. In addition, you can configure a hardware interrupt. A *comparison value* can be specified via the parametrization respectively the job interface of ↗ 'SFB 47 - COUNT - Counter controlling' on page 142.

5.6.7.4 Additional functions counter 3

Exclusively counter 3 has the following additional functions:

- HW gate via *Gate 3*
- Latch function

5.6.7.4.1 HW gate via *Gate 3*

Starting, stopping and interrupting a count function of counter 3 happens via the internal gate (I gate). The i gate is the result of logic operation of HW gate and SW gate. The HW gate evaluation of the connection '*Gate 3*' may be deactivated by the parametrization. With a de-activated HW gate evaluation the triggering exclusively happens by setting the SW gate. ↪ '*SFB 47 - COUNT - Counter controlling*' on page 142

Counter 3:

SW gate	HW gate	Gate function	Reaction counter 3:
Edge 0-1	de-activated	Abort count process	Restart with load value
Edge 0-1	de-activated	Interrupt count process	Continue
Edge 0-1	1	Abort count process	Continue
1	Edge 0-1	Abort count process	Restart with load value
Edge 0-1	1	Interrupt count process	Continue
1	Edge 0-1	Interrupt count process	Continue

Counter 3 - count once

If the internal gate has been closed automatically it may only be opened again under the following conditions:

SW gate	HW gate	I gate
1	Edge 0-1	1
Edge 0-1 (after edge 0-1 at HW gate)	Edge 0-1	1

5.6.7.4.2 Latch function

Function

- As soon as during a count process an edge 0-1 is recognized at the "Latch" input of counter 3, the current counter value is stored in the according latch register.
- You may access the latch value via the parameter LATCHVAL of ↪ '*SFB 47 - COUNT - Counter controlling*' on page 142.
- A just in LATCHVAL loaded value remains after a STOP-RUN transition.

5.6.7.5 Counter output channel

Characteristics of the output

Each counter has an output channel. You pre-define the behavior of the counter output via the parametrization:

- no comparison:
 - The output is used as normal output.
 - ↪ ‘SFB 47 - COUNT - Counter controlling’ on page 142:
The input parameter CTRL_DO is effect less.
The status bits STS_DO and STS_CMP (status comparator in the instance DB) remain reset.
- Counter value \geq comparison value respectively counter value \leq comparison value
 - The output remains set as long as the counter value is higher or equal *comparison value* respectively lower or equal *comparison value*.
 - ↪ ‘SFB 47 - COUNT - Counter controlling’ on page 142:
Control bit CTRL_DO must be set.
The comparison result is shown by the status bit STS_CMP. This status bit may only be reset if the comparison condition is no longer fulfilled.
- Pulse at comparison value
 - When the counter reaches the *comparison value* the output is set for the parametrized *pulse duration*. When you've set a main counting direction the output is only set at reaching the *comparison value* from the main counting direction.
If the *pulse duration* = 0, the output is set until the comparison condition is no longer fulfilled.
 - ↪ ‘SFB 47 - COUNT - Counter controlling’ on page 142:
Control bit CTRL_DO must be set.
The status of the digital output may be shown by the status bit ST_DO.
The comparison result is shown by the status bit STS_CMP. The bit may only be reset if the *pulse duration* has expired.
- Pulse duration
 - The *pulse duration* starts with the setting of the according digital output.
 - The inaccuracy of the *pulse duration* is less than 1ms.
 - There is no past triggering of the *pulse duration* when the *comparison value* has been left and reached again during pulse output.
 - If the *pulse duration* is changed during operation, it will take effect with the next pulse.
 - If the *pulse duration* = 0, the output is set until the comparison condition is no longer fulfilled.
 - Range of values: 0...510ms in steps of 2ms

5.6.7.6 Hysteresis function

Hysteresis

- The *hysteresis* serves the avoidance of many toggle processes of the output and the interrupt, if the *counter value* is in the range of the *comparison value*.
- For the *hysteresis* you may set a range of 0 to 255.
- The settings 0 and 1 deactivate the *hysteresis*.

- The *hysteresis* influences zero run, comparison, over- and under-flow.
- An activated *hysteresis* remains active after a change. The new *hysteresis* range is activated with the next *hysteresis* event.

The following pictures illustrate the output behavior for *hysteresis* 0 and *hysteresis* 3 for the according conditions:

Effect at counter value \geq comparison value

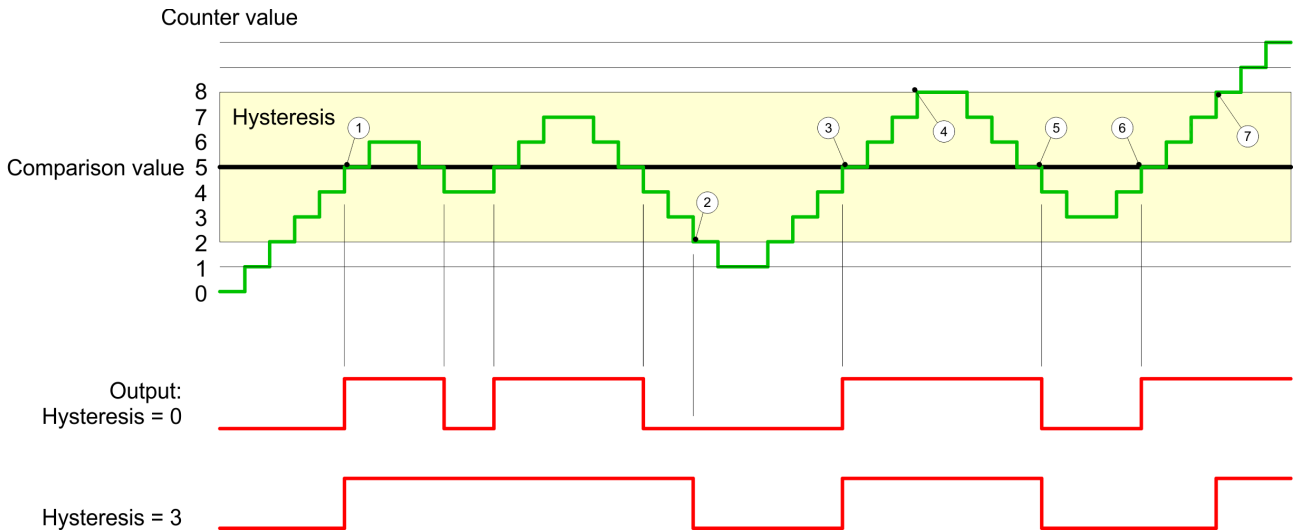

- 1 Counter value \geq comparison value \rightarrow output is set and *hysteresis* activated
- 2 Leave *hysteresis* range \rightarrow output is reset
- 3 Counter value \geq comparison value \rightarrow output is set and *hysteresis* activated
- 4 Leave *hysteresis* range, output remains set for counter value \geq comparison value
- 5 counter value $<$ comparison value and *hysteresis* active \rightarrow output is reset
- 6 counter value \geq comparison value \rightarrow output is not set for *hysteresis* active
- 7 Leave *hysteresis* range, output remains set for counter value \geq comparison value

With reaching the comparison condition the *hysteresis* gets active. At active *hysteresis* the comparison result remains unchanged until the counter value leaves the set *hysteresis* range. After leaving the *hysteresis* range a new *hysteresis* is only activated with again reaching the comparison conditions.

Effect at pulse at comparison value with pulse duration Zero

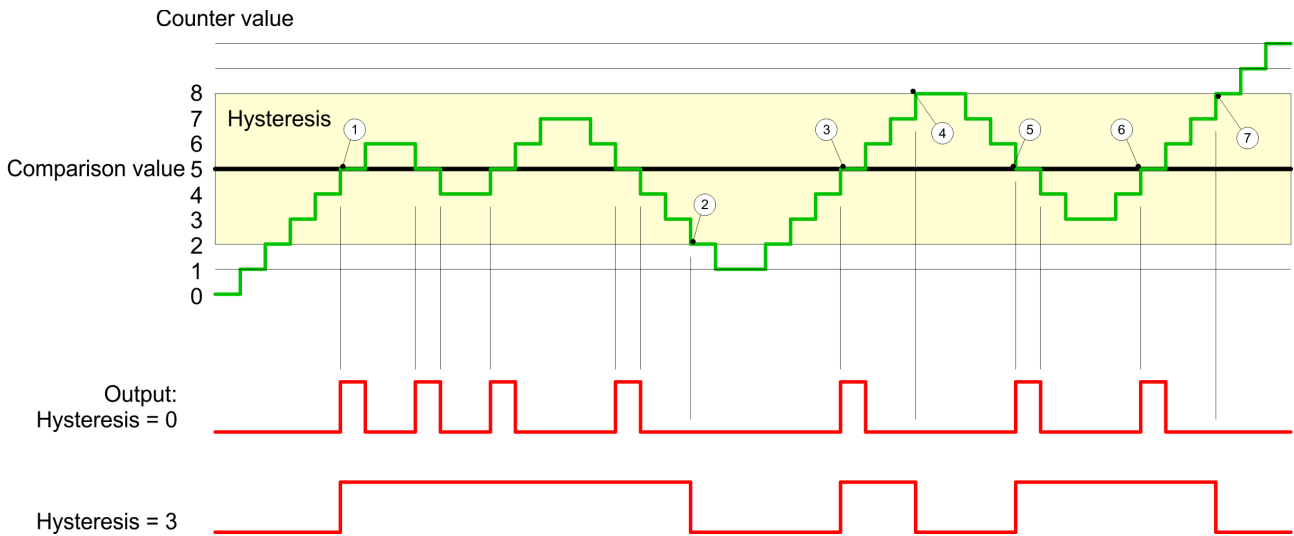

- 1 Counter value = comparison value → output is set and hysteresis activated
- 2 Leave hysteresis range → output is reset and counter value < comparison value
- 3 Counter value = comparison value → output is set and hysteresis activated
- 4 Output is reset for leaving hysteresis range and counter value > comparison value
- 5 Counter value = comparison value → output is set and hysteresis activated
- 6 Counter value = comparison value and hysteresis active → output remains set
- 7 Leave hysteresis range and counter value > comparison value → output is reset

With reaching the comparison condition the hysteresis gets active. At active hysteresis the comparison result remains unchanged until the counter value leaves the set hysteresis range. After leaving the hysteresis range a new hysteresis is only activated with again reaching the comparison conditions.

Effect at pulse at comparison value with pulse duration not zero

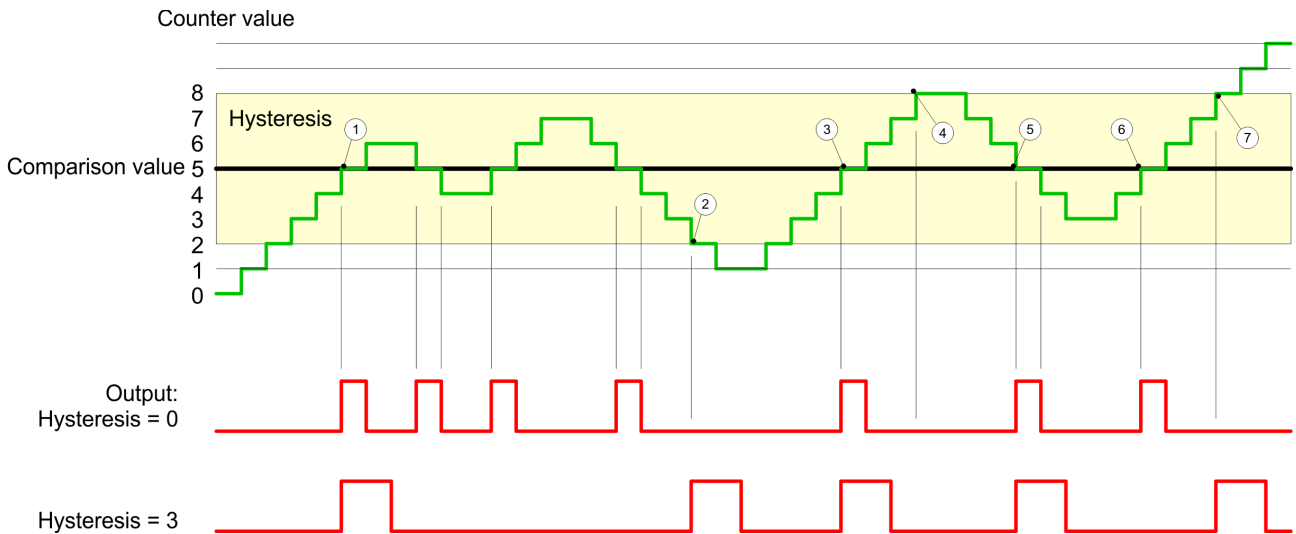

- 1 Counter value = comparison value → pulse of the parameterized pulse duration is put out, the hysteresis is activated and the counting direction stored
- 2 Leaving the hysteresis range contrary to the stored counting direction → pulse of the parameterized pulse duration is put out, the hysteresis is de-activated
- 3 Counter value = comparison value → pulse of the parameterized pulse duration is put out, the hysteresis is activated and the counting direction stored
- 4 Leaving the hysteresis range without changing counting direction → hysteresis is de-activated
- 5 Counter value = comparison value → pulse of the parameterized pulse duration is put out, the hysteresis is activated and the counting direction stored
- 6 Counter value = comparison value and hysteresis active → no pulse
- 7 Leaving the hysteresis range contrary to the stored counting direction → pulse of the parameterized pulse duration is put out, the hysteresis is de-activated

With reaching the comparison condition the hysteresis gets active and a pulse of the parameterized duration is put out. As long as the counter value is within the hysteresis range, no other pulse is put out. With activating the hysteresis the counting direction is stored in the module. If the counter value leaves the hysteresis range contrary to the stored counting direction, a pulse of the parameterized duration is put out. Leaving the hysteresis range without direction change, no pulse is put out.

5.6.8 Diagnostics and interrupt

Overview

GSDML

- Edge at an digital interrupt input

Via the hardware configuration you can define the following trigger for a hardware interrupt that can trigger a diagnostics interrupt:

- Reaching the comparison value
- Overflow respectively at overrun upper counter limit
- Underflow respectively at underrun lower counter limit
- Opening the HW gate with open SW gate - except for counter 3
- Closing the HW gate with open SW gate - except for counter 3

5.7 Frequency measurement

5.7.1 Properties

- In this operating mode the CPU counts the incoming pulses during a specified integration time and outputs them as frequency value.
- Integration time 10ms ... 10000ms in steps of 1ms configurable
- Control by the user program ↪ *'SFB 48 - FREQUENC - Frequency measurement'* on page 170

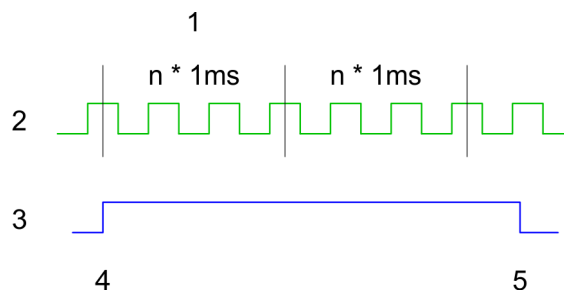

- 1 Integration time
- 2 Counting pulse
- 3 SW gate
- 4 Frequency measurement start
- 5 Frequency measurement stop

Measuring procedure

- The measurement is carried out during the integration time and is updated after the integration time has expired.
- If the period of the measured frequency exceeds the assigned integration time, this means there was no edge 0-1 during the measurement, the measurement value 0 is returned.
- The calculated frequency value is supplied in "mHz" units.
- The measurement value can be read with *MEAS_VAL* from ↪ *'SFB 48 - FREQUENC - Frequency measurement'* on page 170.
- The number of activated channels does not influence the max. frequency, which is defined in the technical data.

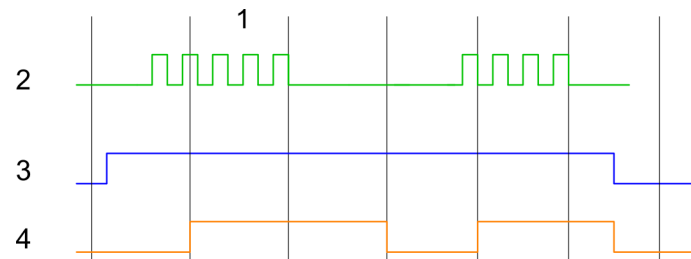

- 1 Integration time
- 2 Counting pulse
- 3 SW gate
- 4 Evaluated frequency



The counting function is disabled during the pulse width modulation on the same channel.

5.7.2 Wiring

5.7.2.1 Frequency measurement inputs

Connect the signal to be measured at input B of the corresponding counter.

X4: Connector

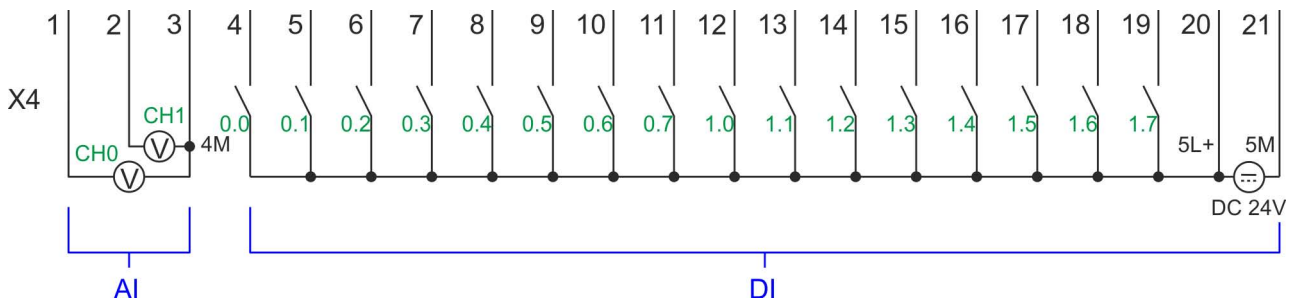

Pos.	Function	Type	Description
1	AI 0	I	AI0: Analog input AI 0
2	AI 1	I	AI1: Analog input AI 1
3	Analog 0V	I	4M: GND for analog inputs
4	DI 0	I	+0.0: Digital input DI 0 / Counter 0 (A) *
5	DI 1	I	+0.1: Digital input DI 1 / Counter 0 (B) / Frequency 0 *
6	DI 2	I	+0.2: Digital input DI 2
7	DI 3	I	+0.3: Digital input DI 3 / Counter 1 (A) *
8	DI 4	I	+0.4: Digital input DI 4 / Counter 1 (B) / Frequency 1 *
9	DI 5	I	+0.5: Digital input DI 5
10	DI 6	I	+0.6: Digital input DI 6 / Counter 2 (A) *
11	DI 7	I	+0.7: Digital input DI 7 / Counter 2 (B) / Frequency 2 *
12	DI 8	I	+1.0: Digital input DI 8
13	DI 9	I	+1.1: Digital input DI 9 / Counter 3 (A) *
14	DI 10	I	+1.2: Digital input DI 10 / Counter 3 (B) / Frequency 3 *
15	DI 11	I	+1.3: Digital input DI 11 / Gate 3 *
16	DI 12	I	+1.4: Digital input DI 12
17	DI 13	I	+1.5: Digital input DI 13
18	DI 14	I	+1.6: Digital input DI 14
19	DI 15	I	+1.7: Digital input DI 15 / Latch 3 *
20	DC 24V	I	5L+: DC 24V for onboard DI power section supply
21	0 V	I	5M: GND for onboard DI power section supply

*) Max. input frequency 100kHz otherwise 1kHz.

5.7.3 Proceeding

Hardware configuration

In the Siemens SIMATIC Manager the following steps should be executed:

1. ▶ Perform a hardware configuration for the CPU. ↪ *'Hardware configuration - CPU'* on page 61
2. ▶ Double-click the counter sub module of the CPU 314C-2 PN/DP.
⇒ The dialog *'Properties'* is opened.
3. ▶ As soon as you select the operating mode for the corresponding channel, a dialog box with default values for this counter mode is created and shown. Select for the corresponding channel the operating mode *'Frequency counting'*. ↪ *'Counter operating modes'* on page 153
4. ▶ Perform the required parameter settings.
5. ▶ Save your project with *'Station → Safe and compile'*.
6. ▶ Transfer your project to your CPU.

User program

- The ↪ *'SFB 48 - FREQUENC - Frequency measurement'* on page 170 should cyclically be called (e.g. OB 1) for controlling the frequency measurement.
- The SFB is to be called with the corresponding instance DB. Here the parameters of the SFB are stored.

5.7.4 SFB 48 - FREQUENC - Frequency measurement

Description

The SFB 48 is a specially developed block for compact CPUs for frequency measurement.

- The SFB FREQUENC should cyclically be called (e.g. OB 1) for controlling the frequency measurement.
- The SFB is to be called with the corresponding instance DB. Here the parameters of the SFB are stored.
- Among others the SFB 48 contains a request interface. Hereby you get read and write access to the registers of the frequency meter.
- So that a new job may be executed, the previous job must have been finished with *JOB_DONE = TRUE*.
- Per channel you may call the SFB in each case with the same instance DB, since the data necessary for the internal operational are stored here. Writing accesses to outputs of the instance DB is not permissible.
- With the SFB FREQUENC (SFB 48) you have following functional options:
 - Start/Stop the frequency meter via software gate *SW_GATE*
 - Read the status bit
 - Read the evaluated frequency
 - Request to read/write internal registers of the frequency meter.

Parameters

Name	Declaration	Data type	Address (Inst.-DB)	Default value	Comment
LADDR	INPUT	WORD	0.0	300h	This parameter is not evaluated. Always the internal I/O periphery is addressed.
CHANNEL	INPUT	INT	2.0	0	Channel number
SW_GATE	INPUT	BOOL	4.0	FALSE	Enables the Software gate
JOB_REQ	INPUT	BOOL	4.3	FALSE	Initiates the job (edge 0-1)
JOB_ID	INPUT	WORD	6.0	0	Job ID
JOB_VAL	INPUT	DINT	8.0	0	Value for write jobs
STS_GATE	OUTPUT	BOOL	12.0	FALSE	Status of the internal gate
MEAS_VAL	OUTPUT	DINT	14.0	0	Evaluated frequency
JOB_DONE	OUTPUT	BOOL	22.0	TRUE	New job can be started.
JOB_ERR	OUTPUT	BOOL	22.1	FALSE	Job error
JOB_STAT	OUTPUT	WORD	24.0	0	Job error ID

Local data only in instance DB

Name	Data type	Address (Instance DB)	Default	Comment
JOB_OVAL	DINT	28.0	-	Output value for read request.



Per channel you may call the SFB in each case with the same instance DB, since the data necessary for the internal operational are stored here. Writing accesses to outputs of the instance DB is not permissible.

Frequency meter request interface

To read/write the registers of the frequency meter the request interface of the SFB 48 may be used.

So that a new job may be executed, the previous job must have be finished with `JOB_DONE = TRUE`.

Proceeding

The deployment of the request interface takes place at the following sequence:

➔ Edit the following input parameters:

Name	Data type	Address (DB)	Default	Comment
JOB_REQ	BOOL	4.3	FALSE	Initiates the job (edges 0-1)
JOB_ID	WORD	6.0	0	Job ID: 00h Job without function 04h Writes the integration time 84h Read the integration time
JOB_VAL	DINT	8.0	0	Value for write jobs. Permitted value for integration time: 10 ... 10000ms

➔ Call the SFB. The job is processed immediately. *JOB_DONE* only applies to SFB run with the result FALSE. *JOB_ERR* = TRUE if an error occurred. Details on the error cause are indicated at *JOB_STAT*.

Name	Data type	Address (DB)	Default	Comment
JOB_DONE	BOOL	22.0	TRUE	New job can be started
JOB_ERR	BOOL	22.1	FALSE	Job error
JOB_STAT	WORD	24.0	0000h	Job error ID 0000h No error 0221h Integration time too low 0222h Integration time too high 02FFh Invalid job ID 8001h Parameter error 8009h Channel no. not valid

1. ➔ A new job may be started with *JOB_DONE* = TRUE.
2. ➔ A value to be read of a read job may be found in *JOB_OVAL* in the instance DB at address 28.

Channel no. not valid

(8009h and Parameter error 8001h)

If you have preset a CHANNEL number greater than 3, the error "Channel no. not valid " (8009h) is reported. if you have preset a CHANNEL number greater than the maximum channel number of the CPU, "Parameter error" (8001h) is reported.

Controlling frequency meter

The frequency meter is controlled by the internal gate (I gate). The I gate is identical to the software gate (SW gate).

SW gate:

open (activate): In the user program by setting *SW_GATE* of SFB 48
 close (deactivate): In the user program by resetting *SW_GATE* of SFB 48

5.7.5 Parametrization

5.7.5.1 Address assignment

Sub module	Input address	Access	Assignment
Counter	816	DINT	Channel 0: Counter value / Frequency value
	820	DINT	Channel 1: Counter value / Frequency value
	824	DINT	Channel 2: Counter value / Frequency value
	828	DINT	Channel 3: Counter value / Frequency value

Sub module	Output address	Access	Assignment
Counter	816	DWORD	reserved
	820	DWORD	reserved
	824	DWORD	reserved
	828	DWORD	reserved

5.7.5.2 Interrupt selection

Via *Basic parameters* you can reach *Select interrupt*. Here you can define the interrupts the CPU will trigger. The following parameters are supported:

- None: The interrupt function is de-activated.
- Process: The following events of the frequency measurement can trigger a hardware interrupt (selectable via *Frequency counting*):
 - End of measurement
- Diagnostics and process: A diagnostics interrupt is only triggered when a hardware interrupt was lost.

5.7.5.3 Operating mode per channel

Parameter hardware configuration

Select via *Channel* the channel select via *Operating* the operating mode. The following operating modes are supported:

- Not parameterized: Channel is deactivated
- ↪ *Count continuously* on page 153
- ↪ *Count once* on page 154
- ↪ *Count Periodically* on page 157
- ↪ *Frequency measurement* on page 167
- ↪ *Pulse width modulation - PWM* on page 176

Depending on the selected operating mode default values are loaded and shown in an additional register.

5.7.5.4 Frequency measurement

Parameter hardware configuration

Default values and structure of this dialog box depend on the selected 'Operating mode'. The following parameters are supported:

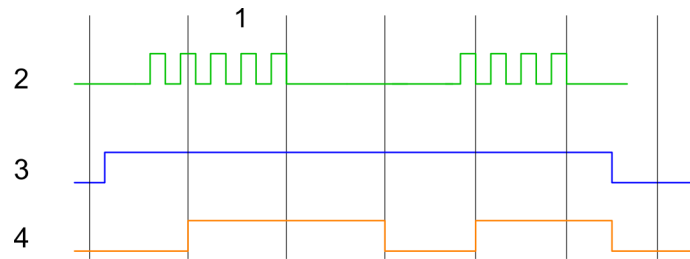



- 1 Integration time
- 2 Counting pulse
- 3 SW gate
- 4 Evaluated frequency

Parameter overview

Operating parameters	Description	Assignment
Integration time	Specify the integration time Range of values: 10ms ... 10000ms in steps of 1ms	100ms
max. counting frequency...	Specify the max. Frequency for the corresponding input Range of values: 1, 2, 5, 10, 30, 60kHz	60kHz
Hardware interrupt	Description	Assignment
End of measurement	Hardware interrupt at end of measurement	de-activated

5.7.6 Status indication

Digital input	LED  green	Description
DI +0.0 DI +0.7	●	Digital I+0.0 ... 0.7 has "1" signal
	○	Digital I+0.0 ... 0.7 has "0" signal
DI +1.0 ... DI +1.7	●	Digital I+1.0 ... 1.7 has "1" signal
	○	Digital input I+1.0 ... 1.7 has "0" signal

Digital output	LED  green	Description
DO +0.0 ... DO +0.7	●	Digital output Q+0.0 ... 0.7 has "1" signal
	○	Digital output Q+0.0 ... 0.7 has "0" signal
DO +1.0 ... DO +1.3	●	Digital output Q+1.0 ... 1.3 has "1" signal
	○	Digital output Q+1.0 ... 1.3 has "0" signal

Power supply	LED  green	Description
1L+	●	DC 24V electronic section supply
	○	DC 24V electronic section supply not available
2L+	●	DC 24V power section supply outputs OK
	○	DC 24V power section supply outputs OK
3L+	●	DC 24V power section supply SLIO bus OK
	○	DC 24V power section supply SLIO bus not available
5L+	●	DC 24V power section supply inputs OK
	○	DC 24V power section supply inputs not available

Error	LED  red	Description
1F	●	Error, overload respectively short circuit on power supply sensor
	○	no error
2F	●	Error, overload respectively short circuit on the outputs
	○	no error

on: ● | off: ○

5.8 Pulse width modulation - PWM

5.8.1 Properties

- By presetting of time parameters, the CPU evaluates a pulse sequence with according pulse/pause ratio and outputs it via the according output channel.
- Channel 0 and 1 are supported
- Control by the user program ↗ 'SFB 49 - PULSE - Pulse width modulation' on page 178

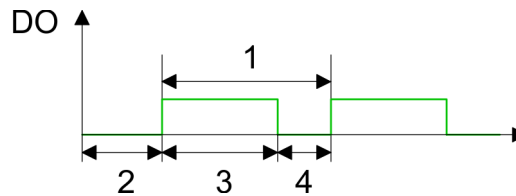

- 1 Period
- 2 On-delay
- 3 Pulse duration
- 4 Pulse pause



The counting function is disabled during the pulse width modulation on the same channel.

5.8.2 Wiring

5.8.2.1 Pulse width modulation outputs

X5: Connector

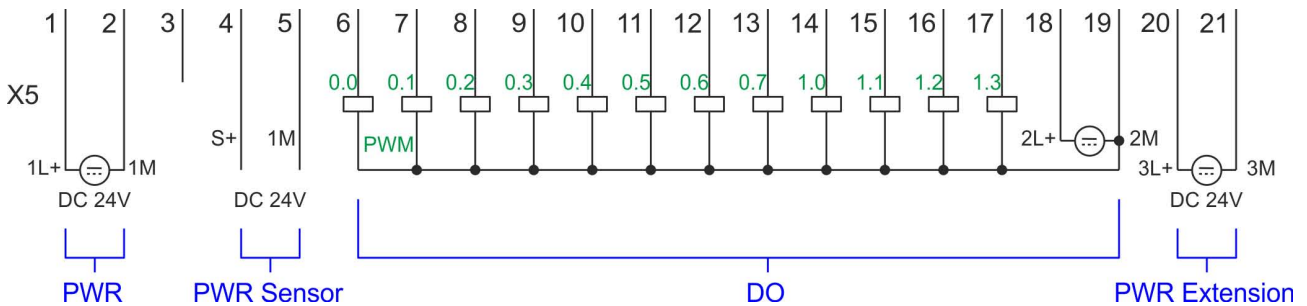

Pos.	Function	Type	Description
1	Sys DC 24V	I	1L+: DC 24V for electronic section supply
2	Sys 0V	I	1M: GND for electronic section supply
3	---	---	reserved
4	DC 24V	O	S+: DC 24V for sensor
5	0V	O	1M: GND for sensor
6	DO 0	O	+0.0: Digital output DO 0 / PWM 0 / Output channel counter 0
7	DO 1	O	+0.1: Digital output DO 1 / PWM 1 / Output channel counter 1
8	DO 2	O	+0.2: Digital output DO 2 / Output channel counter 2
9	DO 3	O	+0.3: Digital output DO 3 / Output channel counter 3
10	DO 4	O	+0.4: Digital output DO 4
11	DO 5	O	+0.5: Digital output DO 5
12	DO 6	O	+0.6: Digital output DO 6
13	DO 7	O	+0.7: Digital output DO 7
14	DO 8	O	+1.0: Digital output DO 8
15	DO 9	O	+1.1: Digital output DO 9
16	DO 10	O	+1.2: Digital output DO 10
17	DO 11	O	+1.3: Digital output DO 11
18	DC 24V	I	2L+: DC 24V for onboard DO power section supply
19	0 V	I	2M: GND for onboard DO power section supply / GND PWM
20	DC 24V	I	3L+: DC 24V for SLIO bus power section supply
21	0 V	I	3M: GND for SLIO bus power section supply

5.8.3 Proceeding

Hardware configuration

In the Siemens SIMATIC Manager the following steps should be executed:

1. ▶ Perform a hardware configuration for the CPU. ↗ *'Hardware configuration - CPU'* on page 61
2. ▶ Double-click the counter sub module of the CPU 314C-2 PN/DP.
⇒ The dialog *'Properties'* is opened.
3. ▶ As soon as you select the operating mode for the corresponding channel, a dialog box with default values for this counter mode is created and shown. Select for the corresponding channel the operating mode *'Pulse width modulation - PWM'*. ↗ *'Counter operating modes'* on page 153
4. ▶ Perform the required parameter settings.
5. ▶ Save your project with *'Station → Safe and compile'*.
6. ▶ Transfer your project to your CPU.

User program

- The ↗ *'SFB 49 - PULSE - Pulse width modulation'* on page 178 should cyclically be called (e.g. OB 1) for controlling the pulse width modulation.
- The SFB is to be called with the corresponding instance DB. Here the parameters of the SFB are stored.

5.8.4 SFB 49 - PULSE - Pulse width modulation

Description

The SFB 49 is a specially developed block for compact CPUs for pulse width modulation.

- The SFB PULSE should cyclically be called (e.g. OB 1) for controlling the frequency measurement.
- The SFB is to be called with the corresponding instance DB. Here the parameters of the SFB are stored.
- Among others the SFB 49 contains a request interface. Hereby you get read and write access to the registers of the pulse width modulation.
- So that a new job may be executed, the previous job must have been finished with *JOB_DONE = TRUE*.
- Per channel you may call the SFB in each case with the same instance DB, since the data necessary for the internal operational are stored here. Writing accesses to outputs of the instance DB is not permissible.
- With the SFB PULSE (SFB 49) you have following functional options:
 - Start/Stop the pulse width modulation via software gate *SW_GATE*
 - Enabling/controlling of the PWM output
 - Read status bits
 - Request to read/write internal registers of the pulse width modulation

Parameters

Name	Declaration	Data type	Address (Inst.-DB)	Default value	Comment
LADDR	INPUT	WORD	0.0	300h	This parameter is not evaluated. Always the internal I/O periphery is addressed.
CHANNEL	INPUT	INT	2.0	0	Channel number
SW_EN	INPUT	BOOL	4.0	FALSE	Enables the Software gate
OUTP_VAL	INPUT	INT	6.0	0	Output value
JOB_REQ	INPUT	BOOL	8.0	FALSE	Initiates the job (edge 0-1)
JOB_ID	INPUT	WORD	10.0	0	Job ID
JOB_VAL	INPUT	DINT	12.0	0	Value for write jobs
STS_EN	OUTPUT	BOOL	16.0	FALSE	Status of the internal gate
JOB_DONE	OUTPUT	BOOL	16.3	TRUE	New job can be started.
JOB_ERR	OUTPUT	BOOL	16.4	FALSE	Job error
JOB_STAT	OUTPUT	WORD	18.0	0	Job error ID

Local data only in Instance DB

Name	Data type	Address (Instance DB)	Default	Comment
JOB_OVAL	DINT	20.0	-	Output value for read request.



Per channel you may call the SFB in each case with the same instance DB, since the data necessary for the internal operational are stored here. Writing accesses to outputs of the instance DB is not permissible.

PWM Request interface

To read/write the registers of the pulse width modulation the request interface of the SFB 49 may be used.

So that a new job may be executed, the previous job must have be finished with `JOB_DONE = TRUE`.

Proceeding

The deployment of the request interface takes place at the following sequence:

➔ Edit the following input parameters:

Name	Data type	Address (DB)	Default	Comment
JOB_REQ	BOOL	8.0	FALSE	Initiates the job (edges 0-1)
JOB_ID	WORD	10.0	0	Job ID: 00h Job without function 01h write period duration 02h write on-delay 04h write minimum pulse duration 81h read period duration 82h read on-delay 84h read minimum pulse duration
JOB_VAL	DINT	8.0	0	Value for write jobs. -2147483648 (-2^{31}) to +2147483647 ($2^{31}-1$)

➔ Call the SFB. The job is processed immediately. *JOB_DONE* only applies to SFB run with the result FALSE. *JOB_ERR* = TRUE if an error occurred. Details on the error cause are indicated at *JOB_STAT*.

Name	Data type	Address (DB)	Default	Comment
JOB_DONE	BOOL	22.0	TRUE	New job can be started
JOB_ERR	BOOL	22.1	FALSE	Job error
JOB_STAT	WORD	24.0	0000h	Job error ID 0000h No error 0411h Period duration time too low 0412h Period duration time too high 0421h On-delay too low 0422h On-delay too high 0431h Minimum pulse duration too low 0432h Minimum pulse duration too high 04FFh Invalid job ID 8001h Parameter error 8009h Channel no. not valid

1. ➤ A new job may be started with `JOB_DONE = TRUE`.
2. ➤ A value to be read of a read job may be found in `JOB_OVAL` in the instance DB at address 28.

Channel no. not valid (8009h) and Parameter error (8001h)

If you have preset a CHANNEL number greater than 3, the error "Channel no. not valid" (8009h) is reported. if you have preset a CHANNEL number greater than the maximum channel number of the CPU, "Parameter error" (8001h) is reported.

Controlling PWM

The pulse width modulation is controlled by the internal gate (I gate). The I gate is identical to the software gate (SW gate).

SW gate:

open (activate): In the user program by setting `SW_EN` of SFB 49

close (deactivate): In the user program by resetting `SW_EN` of SFB 49



If values during the PWM output are changed, the new values will be issued until the beginning of a new period. A just started period runs always to the end!

5.8.5 Parametrization

5.8.5.1 Address assignment

Sub module	Input address	Access	Assignment
Counter	816	DINT	Channel 0: Counter value / Frequency value
	820	DINT	Channel 1: Counter value / Frequency value
	824	DINT	Channel 2: Counter value / Frequency value
	828	DINT	Channel 3: Counter value / Frequency value

Sub module	Output address	Access	Assignment
Counter	816	DWORD	reserved
	820	DWORD	reserved
	824	DWORD	reserved
	828	DWORD	reserved

5.8.5.2 Operating mode per channel

Parameter hardware configuration

Select via *'Channel'* the channel select via *'Operating'* the operating mode. The following operating modes are supported:

- Not parameterized: Channel is deactivated
- ↻ *'Count continuously'* on page 153
- ↻ *'Count once'* on page 154

- ↪ 'Count Periodically' on page 157
- ↪ 'Frequency measurement' on page 167
- ↪ 'Pulse width modulation - PWM' on page 176

Depending on the selected operating mode default values are loaded and shown in an additional register.

5.8.5.3 Pulse width modulation

Parameter hardware configuration

Default values and structure of this dialog box depend on the selected 'Operating mode'. The following parameters are supported:

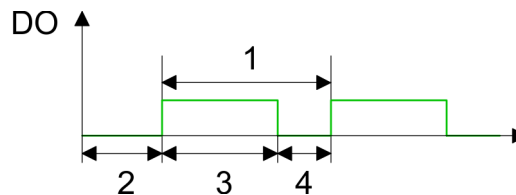

- 1 Period
- 2 On-delay
- 3 Pulse duration
- 4 Pulse pause

Parameter overview

Operating parameters	Description	Assignment
Output format	Here specify the range of values for the output. The CPU hereby determines the pulse duration: <ul style="list-style-type: none"> ■ Per mil <ul style="list-style-type: none"> – Output value is within 0 ... 1000 – Pulse duration = (Output value / 1000) x Period ■ S7 Analog value: <ul style="list-style-type: none"> – Output value is Siemens S7 analog value 0 ... 27648 – Pulse duration = (Output value / 27648) x Period 	Per mil
Time base	Here you can set the time base, which will apply for resolution and range of values of the period duration, minimum pulse duration and on-delay. <ul style="list-style-type: none"> ■ 1ms: Die Time base is 1ms ■ 0.1ms: Time base is 0.1ms 	0.1ms
On-delay	Enter here a value for the time to expire from the start of the output sequence to the output of the pulse. The pulse sequence is output at the output channel, on expiration of the on-delay. <p>Range of values: 0 ... 65535 from this there are the following effective values:</p> <ul style="list-style-type: none"> ■ Time base 1ms: 0 ... 65535ms ■ Time base 0.1ms: 0 ... 6553.5ms 	0

Operating parameters	Description	Assignment
Period	<p>With the period you define the length of the output sequence, which consists of pulse duration and pulse pause.</p> <p>Range of values:</p> <p>Time base 1ms: 1 ... 87ms</p> <p>Time base 0.1ms: 0.4 ... 87.0ms</p>	20000
Minimum pulse duration	<p>With the minimum pulse duration you can suppress short output pulses and short pulse pauses. All pulses or pauses, which are smaller than the minimum pulse duration, are suppressed. This allows you to filter very short pulses (spikes), which can not be recognized by the periphery.</p> <p>Range of values:</p> <p>Time base 1ms: 0 ... $\text{Period} / 2 * 1\text{ms}$</p> <p>Time base 0.1ms: 2 ... $\text{Period} / 2 * 0.1\text{ms}$</p>	2

5.8.6 Status indication

Digital output	LED ■ green	Description
DO +0.0 ... DO +0.7	●	Digital output Q+0.0 ... 0.7 has "1" signal
	○	Digital output Q+0.0 ... 0.7 has "0" signal
DO +1.0 ... DO +1.3	●	Digital output Q+1.0 ... 1.3 has "1" signal
	○	Digital output Q+1.0 ... 1.3 has "0" signal

Power supply	LED ■ green	Description
1L+	●	DC 24V electronic section supply
	○	DC 24V electronic section supply not available
2L+	●	DC 24V power section supply outputs OK
	○	DC 24V power section supply outputs OK
3L+	●	DC 24V power section supply SLIO bus OK
	○	DC 24V power section supply SLIO bus not available
5L+	●	DC 24V power section supply inputs OK
	○	DC 24V power section supply inputs not available

Error	LED ■ red	Description
1F	●	Error power supply sensor
	○	no error
2F	●	Error at overload respectively short circuit at the outputs
	○	no error

on: ● | off: ○

5.9 Diagnostic and interrupt

5.9.1 Overview

Hardware interrupt

The parametrization allows you to define the following trigger for a hardware interrupt:

- Edge at an digital interrupt input
- Reaching the comparison value
- Overflow respectively at overrun upper counter limit
- Underflow respectively at underrun lower counter limit
- Opening the HW gate with open SW gate - except for counter 3
- Closing the HW gate with open SW gate - except for counter 3

Diagnostics interrupt

The VIPA specific parameters allow you to define the following trigger for a diagnostics interrupt ↪ *‘Setting VIPA specific CPU parameters’ on page 70:*

- Hardware interrupt lost
- Error: 2L+ DC 24V DO power section supply
- Error: 3L+ DC 24V SLIO bus power section supply
- Error: 5L+ DC 24V DI power section supply
- Short circuit overload: Sensor
- Short circuit overload: DO

5.9.2 Process interrupt



An interrupt for the corresponding channel operating mode can only be triggered if you have additionally parameterized ‘Diagnostics+Process’ at ‘Select interrupt’ of the ‘Basic parameters’.

A process interrupt causes a call of the OB 40. Within the OB 40 you may find the logical basic address of the module that initialized the process interrupt by using the Local word 6. More detailed information about the initializing event is to find in the *local double word 8*. The assignment of *local double word 8* depends on the parameterized operating mode of each channel.

Local double word 8 of OB 40 at Alarm Inputs

Local byte	Bit 7...0
8	<ul style="list-style-type: none"> ■ Bit 0: Edge at I+0.0 ■ Bit 1: Edge at I+0.1 ■ Bit 2: Edge at I+0.2 ■ Bit 3: Edge at I+0.3 ■ Bit 4: Edge at I+0.4 ■ Bit 5: Edge at I+0.5 ■ Bit 6: Edge at I+0.6 ■ Bit 7: Edge at I+0.7
9	<ul style="list-style-type: none"> ■ Bit 0: Edge at I+1.0 ■ Bit 1: Edge at I+1.1 ■ Bit 2: Edge at I+1.2 ■ Bit 3: Edge at I+1.3 ■ Bit 4: Edge at I+1.4 ■ Bit 5: Edge at I+1.5 ■ Bit 6: Edge at I+1.6 ■ Bit 7: Edge at I+1.7
10...11	<ul style="list-style-type: none"> ■ Bit 7 ... 0: reserved

Local double word 8 of OB 40 at counter function

Local byte	Bit 7...0
8	<ul style="list-style-type: none"> ■ Bit 0: Edge at I+0.0 ■ Bit 1: Edge at I+0.1 ■ Bit 2: Edge at I+0.2 ■ Bit 3: Edge at I+0.3 ■ Bit 4: Edge at I+0.4 ■ Bit 5: Edge at I+0.5 ■ Bit 6: Edge at I+0.6 ■ Bit 7: Edge at I+0.7
9	<ul style="list-style-type: none"> ■ Bit 0: Edge at I+1.0 ■ Bit 1: Edge at I+1.1 ■ Bit 2: Edge at I+1.2 ■ Bit 3: Edge at I+1.3 ■ Bit 4: Edge at I+1.4 ■ Bit 5: Edge at I+1.5 ■ Bit 6: Edge at I+1.6 ■ Bit 7: Edge at I+1.7
10	<ul style="list-style-type: none"> ■ Bit 1, 0: reserved ■ Bit 2: Over-/underflow/end value counter 0 ■ Bit 3: Counter 0 reached comparison value ■ Bit 5, 4: reserved ■ Bit 6: Over-/underflow/ end value counter 1 ■ Bit 7: Counter 1 reached comparison value
11	<ul style="list-style-type: none"> ■ Bit 1, 0: reserved ■ Bit 2: Over-/underflow/end value counter 2 ■ Bit 3: Counter 2 reached comparison value ■ Bit 4: Gate counter 3 open (activated) ■ Bit 5: Gate counter 3 closed ■ Bit 6: Over-/underflow/end value counter 3 ■ Bit 7: Counter 3 reached comparison value

Local double word 8 of OB 40 at *frequency measurement*

Local byte	Bit 7...0
8	<ul style="list-style-type: none"> ■ Bit 0: Edge at I+0.0 ■ Bit 1: Edge at I+0.1 ■ Bit 2: Edge at I+0.2 ■ Bit 3: Edge at I+0.3 ■ Bit 4: Edge at I+0.4 ■ Bit 5: Edge at I+0.5 ■ Bit 6: Edge at I+0.6 ■ Bit 7: Edge at I+0.7
9	<ul style="list-style-type: none"> ■ Bit 0: Edge at I+1.0 ■ Bit 1: Edge at I+1.1 ■ Bit 2: Edge at I+1.2 ■ Bit 3: Edge at I+1.3 ■ Bit 4: Edge at I+1.4 ■ Bit 5: Edge at I+1.5 ■ Bit 6: Edge at I+1.6 ■ Bit 7: Edge at I+1.7
10	<ul style="list-style-type: none"> ■ Bit 0: End of measurement channel 0 (end of the integration time) ■ Bit 3 ... 1: reserved ■ Bit 4: End of measurement channel 1 (end of the integration time) ■ Bit 7 ... 5: reserved
11	<ul style="list-style-type: none"> ■ Bit 0: End of measurement channel 2 (end of the integration time) ■ Bit 3 ... 1: reserved ■ Bit 4: End of measurement channel 3 (end of the integration time) ■ Bit 7 ... 5: reserved

5.9.3 Diagnostic interrupt

Function



An interrupt for the corresponding channel operating mode can only be triggered if you have additionally parameterized 'Diagnostics+Process' at 'Select interrupt' of the 'Basic parameters'.

Via the parameterization (record set 7Fh) you may activate a global diagnostic interrupt for the module. A diagnostic interrupt occurs when during a process interrupt execution in OB 40 another process interrupt is thrown for the same event. The initialization of a diagnostic interrupt interrupts the recent process interrupt execution in OB 40 and branches in OB 82 to diagnostic interrupt processing_{incoming}. If during the diagnostic interrupt processing other events are occurring at other channels that may also cause a process res. diagnostic interrupt, these are interim stored. After the end of the diagnostic interrupt processing at first all interim stored diagnostic interrupts are processed in the sequence of their occurrence and then all process interrupts. If a channel where currently a diagnostic interrupt_{incoming} is pro-

cessed res. interim stored initializes further process interrupts, these get lost. When a process interrupt for which a diagnostic interrupt_{incoming} has been released is ready, the diagnostic interrupt processing is called again as diagnostic interrupt_{outgoing}. All events of a channel between diagnostic interrupt_{incoming} and diagnostic interrupt_{outgoing} are not stored and get lost. Within this time window (1. diagnostic interrupt_{incoming} until last diagnostic interrupt_{outgoing}) the SF-LED of the CPU is on. Additionally for every diagnostic interrupt_{incoming/outgoing} an entry in the diagnostic buffer of the CPU occurs.

Example:

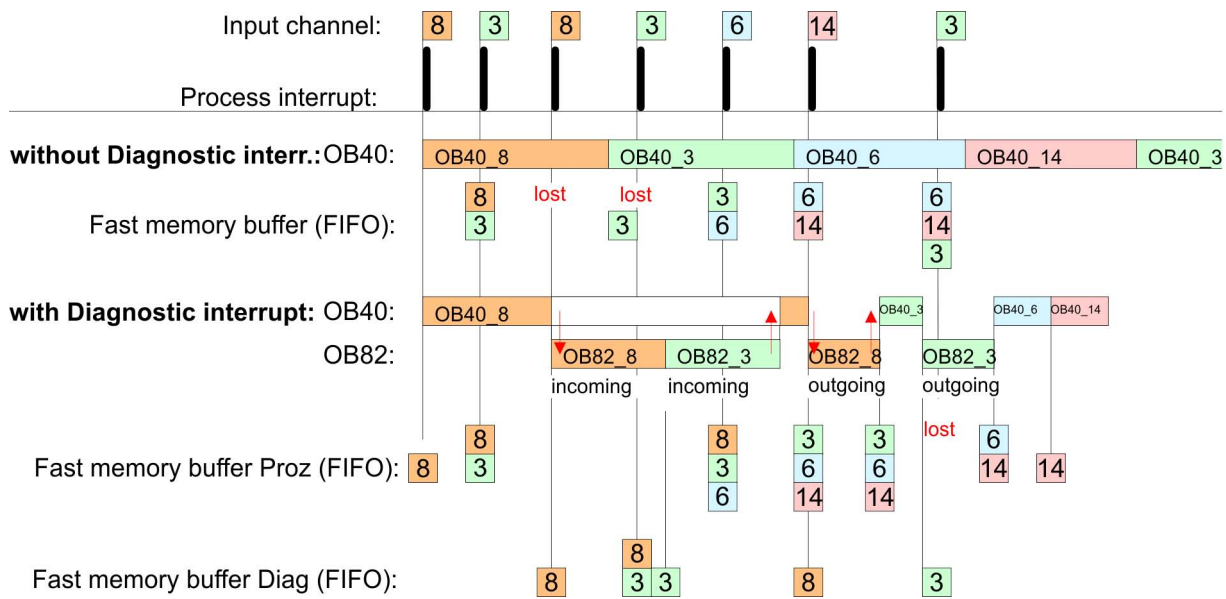

Diagnostic interrupt processing

Every OB 82 call causes an entry in the diagnostic buffer of the CPU containing error cause and module address. By using the SFC 59 you may read the diagnostic bytes. At de-activated diagnostic interrupt you have access to the last recent diagnostic event. If you've activated the diagnostic function in your hardware configuration, the contents of record set 0 are already in the local double word 8 when calling the OB 82. The SFC 59 allows you to also read the record set 1 that contains additional information. After leaving the OB 82 a clear assignment of the data to the last diagnostic interrupt is not longer possible. The record sets of the diagnostic range have the following structure:

Record set 0 Diagnostic_{incoming}

Byte	Bit 7...0
0	<ul style="list-style-type: none"> ■ Bit 0: set at module failure <ul style="list-style-type: none"> – Counter/Frequency measurement: Process interrupt lost – Digital input: Process interrupt lost – Missing power supply DI or DO – Digital output: short circuit/overload – Output Sensor: short circuit/overload – SLIO bus: missing supply fieldbus – Diagnostic interrupt from SLIO modules ■ Bit 1: set at internal error <ul style="list-style-type: none"> – Missing power supply DI or DO – Digital output: short circuit/overload – Output Sensor: short circuit/overload ■ Bit 2: set at external error <ul style="list-style-type: none"> – SLIO bus: missing supply fieldbus ■ Bit 3: set at channel error ■ Bit 4: set at missing external power supply <ul style="list-style-type: none"> – SLIO bus: missing supply fieldbus ■ Bit 7 ... 5: 0 (fix)
1	<ul style="list-style-type: none"> ■ Bit 3 ... 0: Module class <ul style="list-style-type: none"> – 1111b: Digital ■ Bit 4: Channel information present <ul style="list-style-type: none"> – Counter/Frequency measurement: Process interrupt lost – Digital input: Process interrupt lost – Missing power supply DI or DO – Digital output: short circuit/overload – Output Sensor: short circuit/overload – SLIO bus: missing supply fieldbus – Diagnostic interrupt from SLIO modules ■ Bit 7 ... 5: 0 (fix)
2	<ul style="list-style-type: none"> ■ Bit 3 ... 0: 0 (fix) ■ Bit 4: set at missing internal power supply <ul style="list-style-type: none"> – Missing power supply DI or DO ■ Bit 7 ... 5: 0 (fix)
3	<ul style="list-style-type: none"> ■ Bit 5 ... 0: 0 (fix) ■ Bit 6: Process interrupt lost ■ Bit 7: 0 (fix)

Record set 0 Diagnostic_{outgoing}

After the removing error a diagnostic message_{outgoing} takes place if the diagnostic interrupt release is still active.

Byte	Bit 7...0
0	<ul style="list-style-type: none"> ■ Bit 0: set at module failure <ul style="list-style-type: none"> – Counter/Frequency measurement: Process interrupt lost – Digital input: Process interrupt lost – Missing power supply DI or DO – Digital output: short circuit/overload – Output Sensor: short circuit/overload – SLIO bus: missing supply fieldbus – Diagnostic interrupt from SLIO modules ■ Bit 1: set at internal error <ul style="list-style-type: none"> – Missing power supply DI or DO – Digital output: short circuit/overload – Output Sensor: short circuit/overload ■ Bit 2: set at external error <ul style="list-style-type: none"> – SLIO bus: missing supply fieldbus ■ Bit 3: set at channel error ■ Bit 4: set at missing external power supply <ul style="list-style-type: none"> – SLIO bus: missing supply fieldbus ■ Bit 7 ... 5: 0 (fix)
1	<ul style="list-style-type: none"> ■ Bit 3 ... 0: Module class <ul style="list-style-type: none"> – 1111b: Digital ■ Bit 4: Channel information present <ul style="list-style-type: none"> – Counter/Frequency measurement: Process interrupt lost – Digital input: Process interrupt lost – Missing power supply DI or DO – Digital output: short circuit/overload – Output Sensor: short circuit/overload – SLIO bus: missing supply fieldbus – Diagnostic interrupt from SLIO modules ■ Bit 7 ... 5: 0 (fix)
2	<ul style="list-style-type: none"> ■ Bit 3 ... 0: 0 (fix) ■ Bit 4: set at missing internal power supply <ul style="list-style-type: none"> – Missing power supply DI or DO ■ Bit 7 ... 5: 0 (fix)
3	<ul style="list-style-type: none"> ■ Bit 7 ... 0: 0 (fix)



The record set 0 of the alarm interrupts, counter function, frequency measurement and pulse width modulation has the same structure. There are differences in the structure of record set 1.

Diagnostic record set 1 at Alarm Inputs

The record set 1 contains the 4byte of the record set 0 and additionally 12byte module specific diagnostic data. The diagnostic bytes have the following assignment:

Byte	Bit 7...0
0 ... 3	Content record set 0 ↪ 'Record set 0 Diagnostic _{incoming} ' on page 189
4	<ul style="list-style-type: none"> ■ Bit 6 ... 0: Channel type (here 70h) <ul style="list-style-type: none"> – 70h: Digital input ■ Bit 7: More channel types present <ul style="list-style-type: none"> – 0: no – 1: yes
5	Number of diagnostic bits per channel (here 08h)
6	Number of channels of a module (here 08h)
7	<ul style="list-style-type: none"> ■ Bit 0: Error in channel group 0 (I+0.0 ... I+0.3) ■ Bit 1: Error in channel group 1 (I+0.4 ... I+0.7) ■ Bit 2: Error in channel group 2 (I+1.0 ... I+1.3) ■ Bit 3: Error in channel group 2 (I+1.4 ... I+1.7) ■ Bit 7 ... 4: reserved
8	Diagnostic interrupt due to "process interrupt lost" at... <ul style="list-style-type: none"> ■ Bit 0: ... input I+0.0 ■ Bit 1: 0 (fix) ■ Bit 2: ... input I+0.1 ■ Bit 3: 0 (fix) ■ Bit 4: ... input I+0.2 ■ Bit 5: 0 (fix) ■ Bit 6: ... input I+0.3 ■ Bit 7: 0 (fix)
9	Diagnostic interrupt due to "process interrupt lost" at... <ul style="list-style-type: none"> ■ Bit 0: ... input I+0.4 ■ Bit 1: 0 (fix) ■ Bit 2: ... input I+0.5 ■ Bit 3: 0 (fix) ■ Bit 4: ... input I+0.6 ■ Bit 5: 0 (fix) ■ Bit 6: ... input I+0.7 ■ Bit 7: 0 (fix)
10	Diagnostic interrupt due to "process interrupt lost" at... <ul style="list-style-type: none"> ■ Bit 0: ... input I+1.0 ■ Bit 1: 0 (fix) ■ Bit 2: ... input I+1.1 ■ Bit 3: 0 (fix) ■ Bit 4: ... input I+1.2 ■ Bit 5: 0 (fix) ■ Bit 6: ... input I+1.3 ■ Bit 7: 0 (fix)

Byte	Bit 7...0
11	Diagnostic interrupt due to "process interrupt lost" at... <ul style="list-style-type: none"> ■ Bit 0: ... input I+1.4 ■ Bit 1: 0 (fix) ■ Bit 2: ... input I+1.5 ■ Bit 3: 0 (fix) ■ Bit 4: ... input I+1.6 ■ Bit 5: 0 (fix) ■ Bit 6: ... input I+1.7 ■ Bit 7: 0 (fix)
12...15	■ Bit 7 ... 0: reserved

Diagnostic record set 1 at *counter function*

The record set 1 contains the 4byte of the record set 0 and additionally 12byte module specific diagnostic data. The diagnostic bytes have the following assignment:

Byte	Bit 7...0
0 ... 3	Content record set 0 ↪ <i>'Record set 0 Diagnostic_{incoming}'</i> on page 189
4	<ul style="list-style-type: none"> ■ Bit 6 ... 0: Channel type (here 70h) <ul style="list-style-type: none"> – 70h: Digital input – 71h: Analog input – 72h: Digital output – 73h: Analog output – 74h: Analog input/output ■ Bit 7: More channel types present <ul style="list-style-type: none"> – 0: no – 1: yes
5	Number of diagnostic bits per channel (here 08h)
6	Number of channels of a module (here 08h)
7	<ul style="list-style-type: none"> ■ Bit 0: Error in channel group 0 (I+0.0 ... I+0.3) ■ Bit 1: Error in channel group 1 (I+0.4 ... I+0.7) ■ Bit 2: Error in channel group 2 (I+1.0 ... I+1.3) ■ Bit 3: Error in channel group 3 (I+1.4 ... I+1.7) ■ Bit 4: Error in channel group 4 (counter 0) ■ Bit 5: Error in channel group 5 (counter 1) ■ Bit 6: Error in channel group 6 (counter 2) ■ Bit 7: Error in channel group 7 (counter 3)
8	Diagnostic interrupt due to "process interrupt lost" at... <ul style="list-style-type: none"> ■ Bit 0: ... input I+0.0 ■ Bit 1: 0 (fix) ■ Bit 2: ... input I+0.1 ■ Bit 3: 0 (fix) ■ Bit 4: ... input I+0.2 ■ Bit 5: 0 (fix) ■ Bit 6: ... input I+0.3 ■ Bit 7: 0 (fix)

Byte	Bit 7...0
9	Diagnostic interrupt due to "process interrupt lost" at... <ul style="list-style-type: none"> ■ Bit 0: ... input I+0.4 ■ Bit 1: 0 (fix) ■ Bit 2: ... input I+0.5 ■ Bit 3: 0 (fix) ■ Bit 4: ... input I+0.6 ■ Bit 5: 0 (fix) ■ Bit 6: ... input I+0.7 ■ Bit 7: 0 (fix)
10	Diagnostic interrupt due to "process interrupt lost" at... <ul style="list-style-type: none"> ■ Bit 0: ... input I+1.0 ■ Bit 1: 0 (fix) ■ Bit 2: ... input I+1.1 ■ Bit 3: 0 (fix) ■ Bit 4: ... input I+1.2 ■ Bit 5: 0 (fix) ■ Bit 6: ... input I+1.3 ■ Bit 7: 0 (fix)
11	Diagnostic interrupt due to "process interrupt lost" at... <ul style="list-style-type: none"> ■ Bit 0: ... input I+1.4 ■ Bit 1: 0 (fix) ■ Bit 2: ... input I+1.5 ■ Bit 3: 0 (fix) ■ Bit 4: ... input I+1.6 ■ Bit 5: 0 (fix) ■ Bit 6: ... input I+1.7 ■ Bit 7: 0 (fix)
12	Diagnostic interrupt due to "process interrupt lost" at... <ul style="list-style-type: none"> ■ Bit 3 ... 0: reserved ■ Bit 4: ... over-/underflow/end value counter 0 ■ Bit 5: 0 (fix) ■ Bit 6: ... counter 0 reached comparison value ■ Bit 7: 0 (fix)
13	Diagnostic interrupt due to "process interrupt lost" at... <ul style="list-style-type: none"> ■ Bit 3 ... 0: reserved ■ Bit 4: ... over-/underflow/end value counter 1 ■ Bit 5: 0 (fix) ■ Bit 6: ... counter 1 reached comparison value ■ Bit 7: 0 (fix)

Byte	Bit 7...0
14	Diagnostic interrupt due to "process interrupt lost" at... <ul style="list-style-type: none"> ■ Bit 3 ... 0: reserved ■ Bit 4: ... over-/underflow/end value counter 2 ■ Bit 5: 0 (fix) ■ Bit 6: ... counter 2 reached comparison value ■ Bit 7: 0 (fix)
15	Diagnostic interrupt due to "process interrupt lost" at... <ul style="list-style-type: none"> ■ Bit 0: ... Gate counter 3 closed ■ Bit 1: 0 (fix) ■ Bit 2: ... Gate counter 3 opened ■ Bit 4: ... over-/underflow/end value counter 3 ■ Bit 5: 0 (fix) ■ Bit 6: ... counter 3 reached comparison value ■ Bit 7: 0 (fix)

Diagnostic Record set 1 at *frequency measurement*

The record set 1 contains the 4byte of the record set 0 and additionally 12byte module specific diagnostic data. The diagnostic bytes have the following assignment:

Byte	Bit 7...0
0 ... 3	Content record set 0 ↪ 'Record set 0 Diagnostic _{incoming} ' on page 189
4	<ul style="list-style-type: none"> ■ Bit 6 ... 0: Channel type (here 70h) <ul style="list-style-type: none"> – 70h: Digital input – 71h: Analog input – 72h: Digital output – 73h: Analog output – 74h: Analog input/output ■ Bit 7: More channel types present <ul style="list-style-type: none"> – 0: no – 1: yes
5	Number of diagnostic bits per channel (here 08h)
6	Number of channels of a module (here 08h)
7	<ul style="list-style-type: none"> ■ Bit 0: Error in channel group 0 (I+0.0 ... I+0.3) ■ Bit 1: Error in channel group 1 (I+0.4 ... I+0.7) ■ Bit 2: Error in channel group 2 (I+1.0 ... I+1.3) ■ Bit 3: Error in channel group 3 (I+1.4 ... I+1.7) ■ Bit 4: Error in channel group 4 (Frequency meter 0) ■ Bit 5: Error in channel group 5 (Frequency meter 1) ■ Bit 6: Error in channel group 6 (Frequency meter 2) ■ Bit 7: Error in channel group 7 (Frequency meter 3)

Byte	Bit 7...0
8	Diagnostic interrupt due to "process interrupt lost" at... <ul style="list-style-type: none"> ■ Bit 0: ... input I+0.0 ■ Bit 1: 0 (fix) ■ Bit 2: ... input I+0.1 ■ Bit 3: 0 (fix) ■ Bit 4: ... input I+0.2 ■ Bit 5: 0 (fix) ■ Bit 6: ... input I+0.3 ■ Bit 7: 0 (fix)
9	Diagnostic interrupt due to "process interrupt lost" at... <ul style="list-style-type: none"> ■ Bit 0: ... input I+0.4 ■ Bit 1: 0 (fix) ■ Bit 2: ... input I+0.5 ■ Bit 3: 0 (fix) ■ Bit 4: ... input I+0.6 ■ Bit 5: 0 (fix) ■ Bit 6: ... input I+0.7 ■ Bit 7: 0 (fix)
10	Diagnostic interrupt due to "process interrupt lost" at... <ul style="list-style-type: none"> ■ Bit 0: ... input I+1.0 ■ Bit 1: 0 (fix) ■ Bit 2: ... input I+1.1 ■ Bit 3: 0 (fix) ■ Bit 4: ... input I+1.2 ■ Bit 5: 0 (fix) ■ Bit 6: ... input I+1.3 ■ Bit 7: 0 (fix)
11	Diagnostic interrupt due to "process interrupt lost" at... <ul style="list-style-type: none"> ■ Bit 0: ... input I+1.4 ■ Bit 1: 0 (fix) ■ Bit 2: ... input I+1.5 ■ Bit 3: 0 (fix) ■ Bit 4: ... input I+1.6 ■ Bit 5: 0 (fix) ■ Bit 6: ... input I+1.7 ■ Bit 7: 0 (fix)
12	Diagnostic interrupt due to "process interrupt lost" at... <ul style="list-style-type: none"> ■ Bit 0: End of measurement channel 0 (End of integration time) ■ Bit 7 ... 1: 0 (fix)
13	Diagnostic interrupt due to "process interrupt lost" at... <ul style="list-style-type: none"> ■ Bit 0: End of measurement channel 1 (End of integration time) ■ Bit 7 ... 1: 0 (fix)

Byte	Bit 7...0
14	Diagnostic interrupt due to "process interrupt lost" at... <ul style="list-style-type: none"> ■ Bit 0: End of measurement channel 2 (End of integration time) ■ Bit 7 ... 1: 0 (fix)
15	Diagnostic interrupt due to "process interrupt lost" at... <ul style="list-style-type: none"> ■ Bit 0: End of measurement channel 3 (End of integration time) ■ Bit 7 ... 1: 0 (fix)

Diagnostic record set 1 at pulse width modulation

The record set 1 contains the 4byte of the record set 0 and additionally 12byte module specific diagnostic data. The diagnostic bytes have the following assignment:

Byte	Bit 7...0
0 ... 3	Content record set 0 ↪ 'Record set 0 Diagnostic _{incoming} ' on page 189
4	<ul style="list-style-type: none"> ■ Bit 6 ... 0: Channel type (here 70h) <ul style="list-style-type: none"> – 70h: Digital input – 71h: Analog input – 72h: Digital output – 73h: Analog output – 74h: Analog input/output ■ Bit 7: More channel types present <ul style="list-style-type: none"> – 0: no – 1: yes
5	Number of diagnostic bits per channel (here 08h)
6	Number of channels of a module (here 08h)
7	<ul style="list-style-type: none"> ■ Bit 0: Error in channel group 0 (I+0.0 ... I+0.3) ■ Bit 1: Error in channel group 1 (I+0.4 ... I+0.7) ■ Bit 2: Error in channel group 2 (I+1.0 ... I+1.3) ■ Bit 3: Error in channel group 3 (I+1.4 ... I+1.7) ■ Bit 7 ... 4: reserved
8	Diagnostic interrupt due to "process interrupt lost" at... <ul style="list-style-type: none"> ■ Bit 0: ... input I+0.0 ■ Bit 1: 0 (fix) ■ Bit 2: ... input I+0.1 ■ Bit 3: 0 (fix) ■ Bit 4: ... input I+0.2 ■ Bit 5: 0 (fix) ■ Bit 6: ... input I+0.3 ■ Bit 7: 0 (fix)

Byte	Bit 7...0
9	Diagnostic interrupt due to "process interrupt lost" at... <ul style="list-style-type: none"> ■ Bit 0: ... input I+0.4 ■ Bit 1: 0 (fix) ■ Bit 2: ... input I+0.5 ■ Bit 3: 0 (fix) ■ Bit 4: ... input I+0.6 ■ Bit 5: 0 (fix) ■ Bit 6: ... input I+0.7 ■ Bit 7: 0 (fix)
10	Diagnostic interrupt due to "process interrupt lost" at... <ul style="list-style-type: none"> ■ Bit 0: ... input I+1.0 ■ Bit 1: 0 (fix) ■ Bit 2: ... input I+1.1 ■ Bit 3: 0 (fix) ■ Bit 4: ... input I+1.2 ■ Bit 5: 0 (fix) ■ Bit 6: ... input I+1.3 ■ Bit 7: 0 (fix)
11	Diagnostic interrupt due to "process interrupt lost" at... <ul style="list-style-type: none"> ■ Bit 0: ... input I+1.4 ■ Bit 1: 0 (fix) ■ Bit 2: ... input I+1.5 ■ Bit 3: 0 (fix) ■ Bit 4: ... input I+1.6 ■ Bit 5: 0 (fix) ■ Bit 6: ... input I+1.7 ■ Bit 7: 0 (fix)
12 ... 15	<ul style="list-style-type: none"> ■ Bit 7... 0: reserved

6 Deployment PtP communication

6.1 Fast introduction

General

The CPU has the interface X3 MPI(PtP) with a fix pinout. After an overall reset the interface has MPI functionality. By appropriate configuration the PtP function (**point to point**) can be enabled:

- PtP functionality
 - Using the PtP functionality the RS485 interface is allowed to connect via serial point-to-point connection to different source res. target systems.

Protocols

The protocols respectively procedures ASCII, STX/ETX, 3964R, USS and Modbus are supported.

Parametrization

The parametrization of the serial interface happens during runtime using the FC/SFC 216 (SER_CFG). For this you have to store the parameters in a DB for all protocols except ASCII.

Communication

The FCs/SFCs are controlling the communication. Send takes place via FC/SFC 217 (SER_SND) and receive via FC/SFC 218 (SER_RCV). The repeated call of the FC/SFC 217 SER_SND delivers a return value for 3964R, USS and Modbus via RetVal that contains, among other things, recent information about the acknowledgement of the partner station. The protocols USS and Modbus allow to evaluate the receipt telegram by calling the FC/SFC 218 SER_RCV after SER_SND. The FCs/SFCs are included in the consignment of the CPU.



Use FCs instead SFCs

Please regard that the special VIPA SFCs are not shown in the SLIO CPU. Please use for programming tools e.g. Siemens SIMATIC Manager and TIA Portal the according FCs of the VIPA library.

Overview FCs/SFCs for serial communication

The following FCs/SFCs are used for the serial communication:

FC/SFC		Description
FC/SFC 216	SER_CFG	RS485 parameterize
FC/SFC 217	SER_SND	RS485 send
FC/SFC 218	SER_RCV	RS485 receive

6.2 Principle of the data transfer

Overview

The data transfer is handled during runtime by using FC/SFCs. The principle of data transfer is the same for all protocols and is shortly illustrated in the following.

- Data, which are written into the according data channel by the CPU, is stored in a FIFO send buffer (first in first out) with a size of 2x1024byte and then put out via the interface.
- When the interface receives data, this is stored in a FIFO receive buffer with a size of 2x1024byte and can there be read by the CPU.
- If the data is transferred via a protocol, the embedding of the data to the according protocol happens automatically.
- In opposite to ASCII and STX/ETX, the protocols 3964R, USS and Modbus require the acknowledgement of the partner.
- An additional call of the FC/SFC 217 SER_SND causes a return value in RetVal that includes among others recent information about the acknowledgement of the partner.
- Further on for USS and Modbus after a SER_SND the acknowledgement telegram must be evaluated by a call of the FC/SFC 218 SER_RCV.

RS485 PtP communication

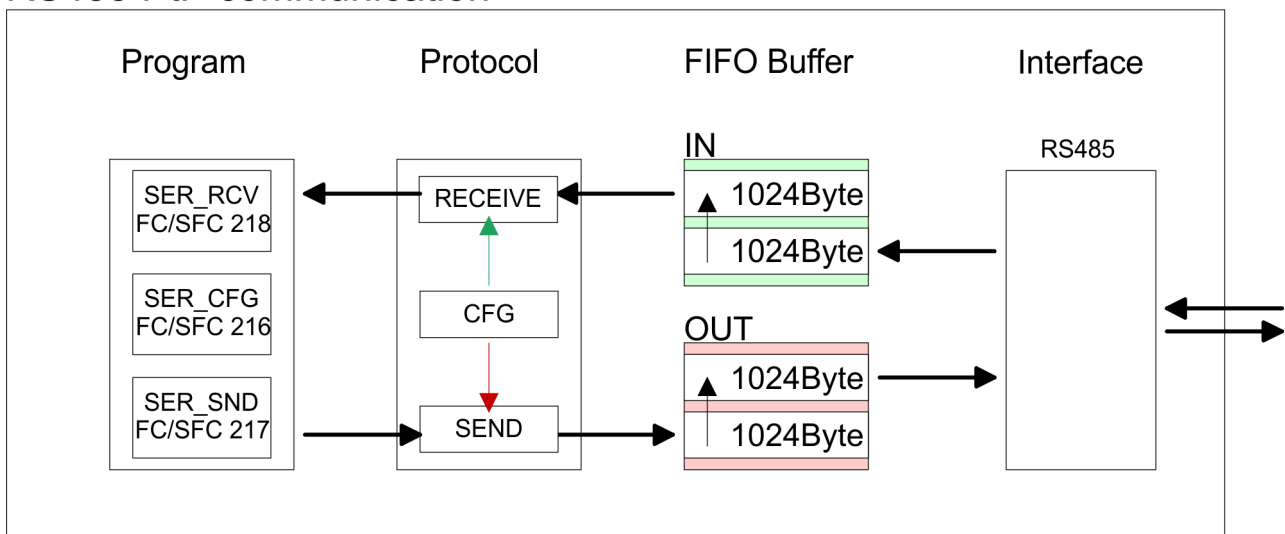

6.3 Enable PtP functionality

Proceeding

After the ↗ *'Hardware configuration - CPU'* on page 61 of the CPU you can set the parameters of the CPU in the virtual IO device *'VIPA SLIO CPU'*.

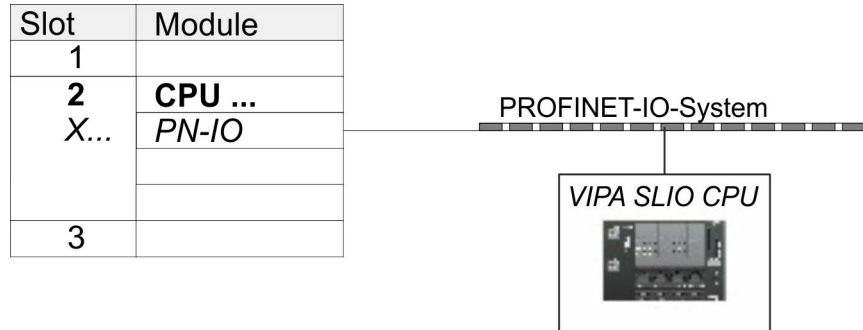

Slot	Module	Order number
0	VIPA SLIO CPU
X2	...	
1		
2		
3		
...		

1. ▶ Open the properties dialog by a double-click at *'VIPA SLIO CPU'*.
 - ⇒ The VIPA specific parameters may be accessed by means of the properties dialog.
2. ▶ Select at *'Function X3'* the value *'PTP'*.
3. ▶ Save and transfer your project to the CPU.
 - ⇒ After a short boot time the interface X3 MPI(PtP) is ready for PtP communication.

6.4 Deployment of RS485 interface for PtP

Properties RS485

- Logical states represented by voltage differences between the two cores of a twisted pair cable
- Serial bus connection in two-wire technology using half duplex mode
- Data communications up to a max. distance of 500m
- Data communication rate up to 115.2kbaud

RS485

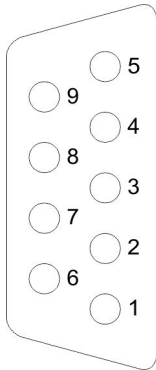

9pin SubD jack

Pin	RS485
1	n.c.
2	M24V
3	RxD/TxD-P (Line B)
4	RTS
5	M5V
6	P5V
7	P24V
8	RxD/TxD-N (Line A)
9	n.c.

Connection

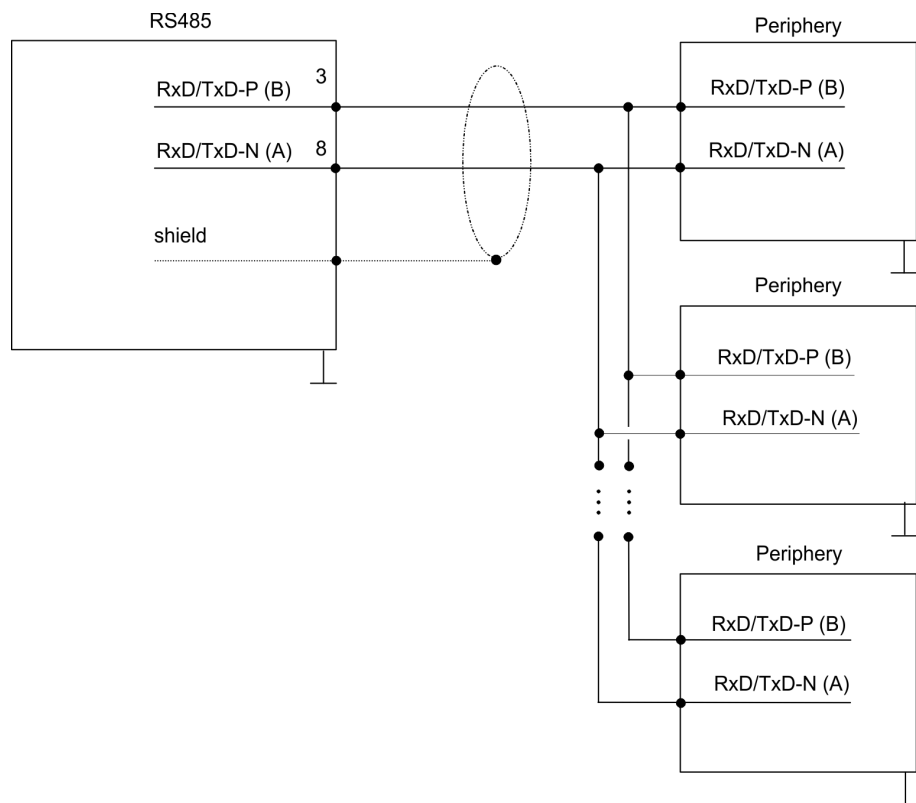

6.5 Parametrization

6.5.1 FC/SFC 216 - SER_CFG

Description

The parametrization happens during runtime deploying the FC/SFC 216 (SER_CFG). You have to store the parameters for STX/ETX, 3964R, USS and Modbus in a DB.

Parameters

Parameter	Declaration	Data type	Description
PROTOCOL	IN	BYTE	1=ASCII, 2=STX/ETX, 3=3964R
PARAMETER	IN	ANY	Pointer to protocol-parameters
BAUDRATE	IN	BYTE	Number of baudrate
CHARLEN	IN	BYTE	0=5bit, 1=6bit, 2=7bit, 3=8bit
PARITY	IN	BYTE	0=Non, 1=Odd, 2=Even
STOPBITS	IN	BYTE	1=1bit, 2=1.5bit, 3=2bit
FLOWCONTROL	IN	BYTE	1 (fix)
RETVAL	OUT	WORD	Return value (0 = OK)

All time settings for timeouts must be set as hexadecimal value. Find the Hex value by multiply the wanted time in seconds with the baudrate.

Example:

Wanted time 8ms at a baudrate of 19200baud

Calculation: $19200\text{bit/s} \times 0.008\text{s} \approx 154\text{bit} \rightarrow (9\text{Ah})$

Hex value is 9Ah.

PROTOCOL

Here you fix the protocol to be used.

You may choose between:

- 1: ASCII
- 2: STX/ETX
- 3: 3964R
- 4: USS Master
- 5: Modbus RTU Master
- 6: Modbus ASCII Master

PARAMETER (as DB)

At ASCII protocol, this parameter is ignored.

At STX/ETX, 3964R, USS and Modbus you fix here a DB that contains the communication parameters and has the following structure for the according protocols:

Data block at STX/ETX			
DBB0:	STX1	BYTE	(1. Start-ID in hexadecimal)
DBB1:	STX2	BYTE	(2. Start-ID in hexadecimal)
DBB2:	ETX1	BYTE	(1. End-ID in hexadecimal)
DBB3:	ETX2	BYTE	(2. End-ID in hexadecimal)
DBW4:	TIMEOUT	WORD	(max. delay time between 2 telegrams)



The start res. end sign should always be a value <20, otherwise the sign is ignored!

With not used IDs please always enter FFh!

Data block at 3964R

DBB0:	Prio	BYTE	(The priority of both partners must be different)
DBB1:	ConnAttmptNr	BYTE	(Number of connection trials)
DBB2:	SendAttmptNr	BYTE	(Number of telegram retries)
DBB4:	CharTimeout	WORD	(Char. delay time)
DBW6:	ConfTimeout	WORD	(Acknowledgement delay time)

Data block at USS

DBW0:	Timeout	WORD	(Delay time)
-------	---------	------	--------------

Data block at Modbus master

DBW0:	Timeout	WORD	(Respond delay time)
-------	---------	------	----------------------

BAUDRATE

Velocity of data transfer in bit/s (baud)

04h:	1200baud	05h:	1800baud	06h:	2400baud	07h:	4800baud
08h:	7200baud	09h:	9600baud	0Ah:	14400baud	0Bh:	19200baud
0Ch:	38400baud	0Dh:	57600baud	0Eh:	115200baud		

CHARLEN

Number of data bits where a character is mapped to.

0: 5bit	1: 6bit	2: 7bit	3: 8bit
---------	---------	---------	---------

PARITY

The parity is -depending on the value- even or odd. For parity control, the information bits are extended with the parity bit, that amends via its value ("0" or "1") the value of all bits to a defined status. If no parity is set, the parity bit is set to "1", but not evaluated.

0: NONE	1: ODD	2: EVEN
---------	--------	---------

STOPBITS

The stop bits are set at the end of each transferred character and mark the end of a character.

1: 1bit	2: 1.5bit*	3: 2bit
*) Only permitted when CHARLEN = 0 (5bit)		

FLOWCONTROL

The parameter *FLOWCONTROL* is ignored. When sending RTS=1, when receiving RTS=0.

RETVAL FC/SFC 216 (Return values)

Return values send by the block:

Error code	Description
0000h	no error
809Ah	Interface not found e. g. interface is used by PROFIBUS In the VIPA SLIO CPU with FeatureSet PTP_NO only the ASCII protocol is configurable. If another protocol is selected the FC/SFC216 also left with this error code.
8x24h	Error at FC/SFC-Parameter x, with x: 1: Error at <i>PROTOCOL</i> 2: Error at <i>PARAMETER</i> 3: Error at <i>BAUDRATE</i> 4: Error at <i>CHARLENGTH</i> 5: Error at <i>PARITY</i> 6: Error at <i>STOPBITS</i> 7: Error at <i>FLOWCONTROL</i>
809xh	Error in FC/SFC parameter value x, where x: 1: Error at <i>PROTOCOL</i> 3: Error at <i>BAUDRATE</i> 4: Error at <i>CHARLENGTH</i> 5: Error at <i>PARITY</i> 6: Error at <i>STOPBITS</i> 7: Error at <i>FLOWCONTROL</i> (parameter is missing)
8092h	Access error in parameter DB (DB too short)
828xh	Error in parameter x of DB parameter, where x: 1: Error 1. parameter 2: Error 2. parameter ...

6.6 Communication

6.6.1 Overview

The communication happens via the send and receive blocks FC/SFC 217 (SER_SND) and FC/SFC 218 (SER_RCV). The FCs/SFCs are included in the consignment of the CPU.

6.6.2 FC/SFC 217 - SER_SND

Description This block sends data via the serial interface. The repeated call of the FC/SFC 217 SER_SND delivers a return value for 3964R, USS and Modbus via RETVAL that contains, among other things, recent information about the acknowledgement of the partner station.

The protocols USS and Modbus require to evaluate the receipt telegram by calling the FC/SFC 218 SER_RCV after SER_SND.

Parameters

Parameter	Declaration	Data type	Description
DATAPTR	IN	ANY	Pointer to Data Buffer for sending data
DATALEN	OUT	WORD	Length of data sent
RETVAL	OUT	WORD	Return value (0 = OK)

DATAPTR Here you define a range of the type Pointer for the send buffer where the data to be sent are stored. You have to set type, start and length.

Example:
Data is stored in DB5 starting at 0.0 with a length of 124byte.
DataPtr:=P#DB5.DBX0.0 BYTE 124

DATALEN Word where the number of the sent Bytes is stored.

At **ASCII** if data were sent by means of FC/SFC 217 faster to the serial interface than the interface sends, the length of data to send could differ from the DATALEN due to a buffer overflow. This should be considered by the user program.

With **STX/ETX, 3964R, Modbus** and **USS** always the length set in **DATAPTR** is stored or 0.

RETVAL FC/SFC 217 (Return values) Return values of the block:

Error code	Description
0000h	Send data - ready
1000h	Nothing sent (data length 0)
20xxh	Protocol executed error free with xx bit pattern for diagnosis
7001h	Data is stored in internal buffer - active (busy)

Error code	Description
7002h	Transfer - active
80xxh	Protocol executed with errors with xx bit pattern for diagnosis (no acknowledgement by partner)
90xxh	Protocol not executed with xx bit pattern for diagnosis (no acknowledgement by partner)
8x24h	Error in FC/SFC parameter x, where x: 1: Error in <i>DATAPTR</i> 2: Error in <i>DATALEN</i>
8122h	Error in parameter <i>DATAPTR</i> (e.g. DB too short)
807Fh	Internal error
809Ah	interface not found e.g. interface is used by PROFIBUS
809Bh	interface not configured

**Protocol specific
RETVAl values**

ASCII

Value	Description
9000h	Buffer overflow (no data send)
9002h	Data too short (0byte)

STX/ETX

Value	Description
9000h	Buffer overflow (no data send)
9001h	Data too long (>1024byte)
9002h	Data too short (0byte)
9004h	Character not allowed

3964R

Value	Description
2000h	Send ready without error
80FFh	NAK received - error in communication
80FEh	Data transfer without acknowledgement of partner or error at acknowledgement
9000h	Buffer overflow (no data send)
9001h	Data too long (>1024byte)
9002h	Data too short (0byte)

USS

Error code	Description
2000h	Send ready without error
8080h	Receive buffer overflow (no space for receipt)
8090h	Acknowledgement delay time exceeded
80F0h	Wrong checksum in respond
80FEh	Wrong start sign in respond
80FFh	Wrong slave address in respond
9000h	Buffer overflow (no data send)
9001h	Data too long (>1024byte)
9002h	Data too short (<2byte)

Modbus RTU/ASCII Master

Error code	Description
2000h	Send ready (positive slave respond)
2001h	Send ready (negative slave respond)
8080h	Receive buffer overflow (no space for receipt)
8090h	Acknowledgement delay time exceeded
80F0h	Wrong checksum in respond
80FDh	Length of respond too long
80FEh	Wrong function code in respond
80FFh	Wrong slave address in respond
9000h	Buffer overflow (no data send)
9001h	Data too long (>1024byte)
9002h	Data too short (<2byte)

Principles of programming

The following text shortly illustrates the structure of programming a send command for the different protocols.

3964R

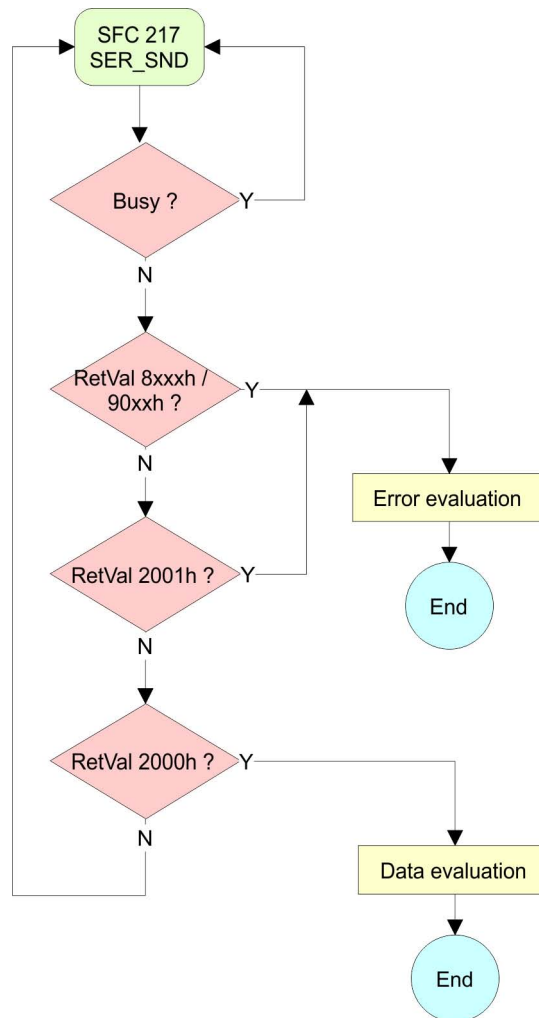

USS / Modbus

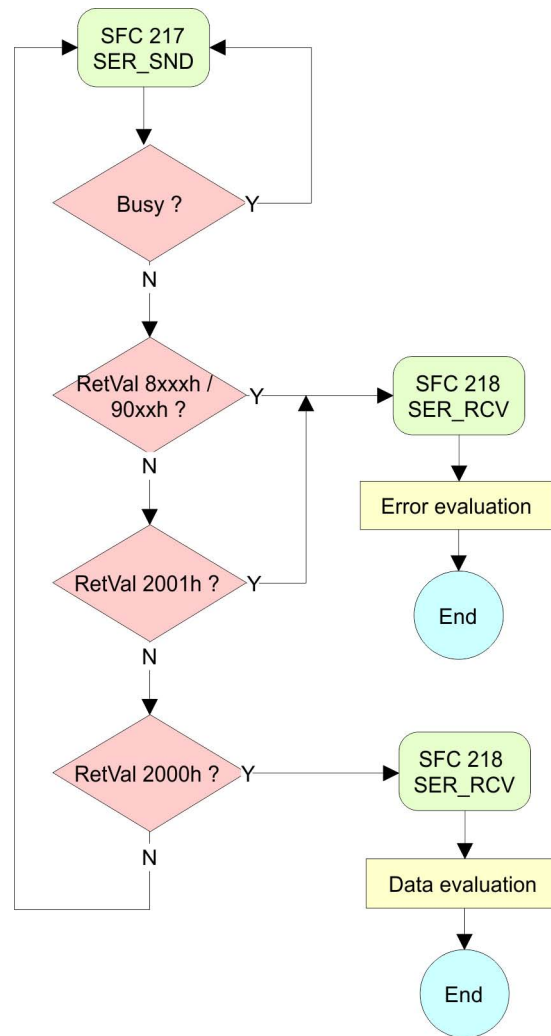

ASCII / STX/ETX

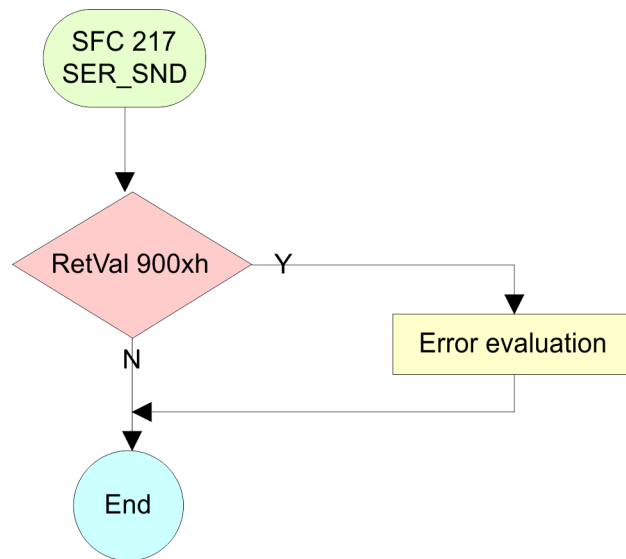

6.6.3 FC/SFC 218 - SER_RCV

Description This block receives data via the serial interface.
Using the FC/SFC 218 SER_RCV after SER_SND with the protocols USS and Modbus the acknowledgement telegram can be read.

Parameters

Parameter	Declaration	Data type	Description
DATAPTR	IN	ANY	Pointer to Data Buffer for received data
DATALEN	OUT	WORD	Length of received data
ERROR	OUT	WORD	Error Number
RETVAL	OUT	WORD	Return value (0 = OK)

DATAPTR Here you set a range of the type Pointer for the receive buffer where the reception data is stored. You have to set type, start and length.

Example:

Data is stored in DB5 starting at 0.0 with a length of 124byte.

DataPtr:=P#DB5.DBX0.0 BYTE 124

DATALEN

Word where the number of received Bytes is stored.

At **STX/ETX** and **3964R**, the length of the received user data or 0 is entered.

At **ASCII**, the number of read characters is entered. This value may be different from the read telegram length.

ERROR

This word gets an entry in case of an error.

The following error messages may be created depending on the protocol:

ASCII

Bit	Error	Description
0	overrun	Overflow, a sign couldn't be read fast enough from the interface
1	framing error	Error that shows that a defined bit frame is not coincident, exceeds the allowed length or contains an additional bit sequence (Stop bit error)
2	parity	Parity error
3	overflow	Buffer is full

STX/ETX

Bit	Error	Description
0	overflow	The received telegram exceeds the size of the receive buffer.
1	char	A sign outside the range 20h ... 7Fh has been received.
3	overflow	Buffer is full.

3964R / Modbus RTU/ASCII Master

Bit	Error	Description
0	overflow	The received telegram exceeds the size of the receive buffer.

**RETVAL FC/SFC 218
(Return value)**

Return values of the block:

Error code	Description
0000h	no error
1000h	Receive buffer too small (data loss)
8x24h	Error at FC/SFC-Parameter x, with x: 1: Error at <i>DATAPTR</i> 2: Error at <i>DATALEN</i> 3: Error at <i>ERROR</i>
8122h	Error in parameter <i>DATAPTR</i> (e.g. DB too short)
809Ah	Serial interface not found res. interface is used by PROFIBUS
809Bh	Serial interface not configured

Principles of programming

The following picture shows the basic structure for programming a receive command. This structure can be used for all protocols.

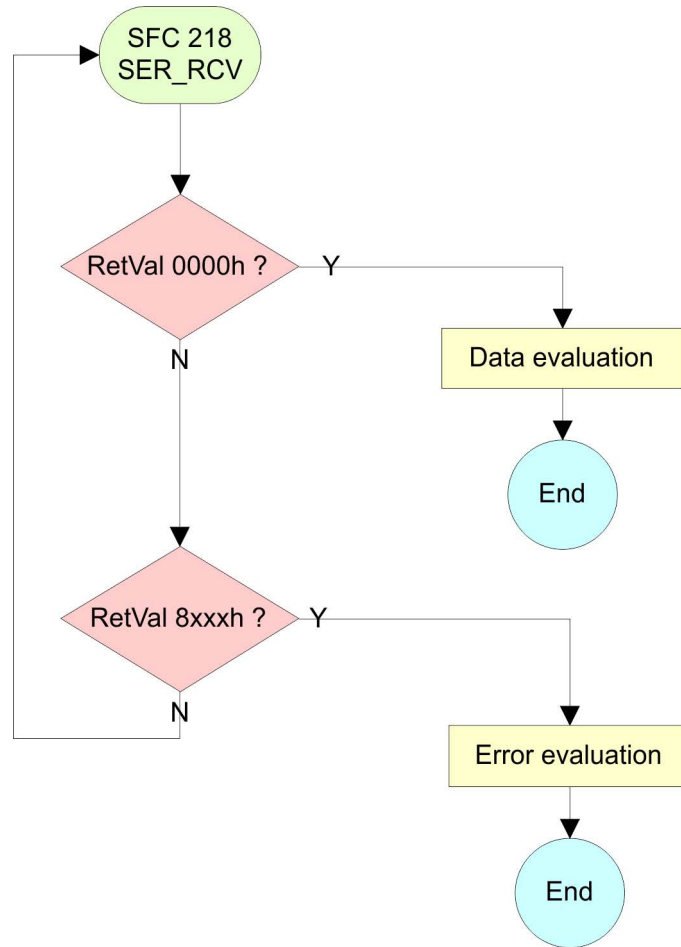

6.7 Protocols and procedures

Overview

The CPU supports the following protocols and procedures:

- ASCII communication
- STX/ETX
- 3964R
- USS
- Modbus

ASCII

ASCII data communication is one of the simple forms of data exchange. Incoming characters are transferred 1 to 1. At ASCII, with every cycle the read FC/SFC is used to store the data that is in the buffer at request time in a parameterized receive data block. If a telegram is spread over various cycles, the data is overwritten. There is no reception acknowledgement. The communication procedure has to be controlled by the concerning user application. An according Receive_ASCII FB may be found within the VIPA library in the service area of www.vipa.com.

STX/ETX

STX/ETX is a simple protocol with start and end ID, where STX stands for **S**tart of **T**ext and ETX for **E**nd of **T**ext.

- Any data transferred from the periphery must be preceded by a Start followed by the data characters and the end character. Depending of the byte width the following ASCII characters can be transferred: 5bit: not allowed: 6bit: 20...3Fh, 7bit: 20...7Fh, 8bit: 20...FFh.
- The effective data, which includes all the characters between Start and End are transferred to the CPU when the End has been received.
- When data is send from the CPU to a peripheral device, any user data is handed to the FC/SFC 217 (SER_SND) and is transferred with added Start- and End-ID to the communication partner.
- You may work with 1, 2 or no Start- and with 1, 2 or no End-ID.
- If no End-ID is defined, all read characters are transferred to the CPU after a parameterizable character delay time (Timeout).

As Start-res. End-ID all Hex values from 01h to 1Fh are permissible. Characters above 1Fh are ignored. In the user data, characters below 20h are not allowed and may cause errors. The number of Start- and End-IDs may be different (1 Start, 2 End res. 2 Start, 1 End or other combinations). For not used start and end characters you have to enter FFh in the hardware configuration.

Message structure:

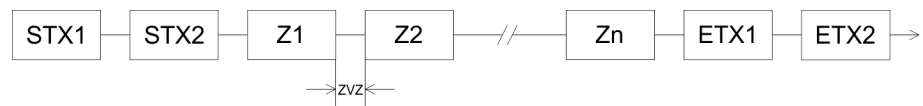

3964

The 3964R procedure controls the data transfer of a point-to-point link between the CPU and a communication partner. The procedure adds control characters to the message data during data transfer. These control characters may be used by the communication partner to verify the complete and error free receipt.

The procedure employs the following control characters:

- STX: **S**tart of **T**ext
- DLE: **D**ata **L**ink **E**scape
- ETX: **E**nd of **T**ext
- BCC: **B**lock **C**heck **C**haracter
- NAK: **N**egative **A**cknowledge

You may transfer a maximum of 255byte per message.

Procedure

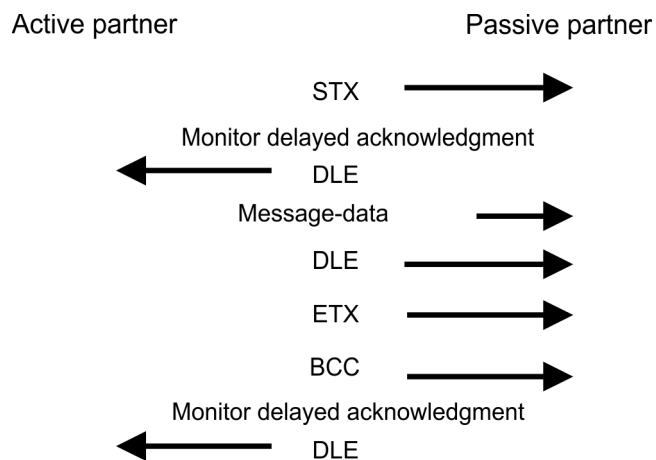

When a DLE is transferred as part of the information it is repeated to distinguish between data characters and DLE control characters that are used to establish and to terminate the connection (DLE duplication). The DLE duplication is reversed in the receiving station.

The 3964R procedure requires that a lower priority is assigned to the communication partner. When communication partners issue simultaneous send commands, the station with the lower priority will delay its send command.

USS

The USS protocol (**U**niverselle **s**erielle **S**chnittstelle = universal serial interface) is a serial transfer protocol defined by Siemens for the drive and system components. This allows to build-up a serial bus connection between a superordinated master and several slave systems. The USS protocol enables a time cyclic telegram traffic by presetting a fix telegram length.

The following features characterize the USS protocol:

- Multi point connection
- Master slave access procedure
- Single master system
- Max. 32 participants
- Simple and secure telegram frame

It is essential:

- You may connect 1 master and max. 31 slaves at the bus
- The single slaves are addressed by the master via an address sign in the telegram.
- The communication happens exclusively in half-duplex operation.
- After a send command, the acknowledgement telegram must be read by a call of the FC/SFC 218 SER_RCV.

The telegrams for send and receive have the following structure:

Master slave telegram

STX	LGE	ADR	PKE		IND		PWE		STW		HSW		BCC
02h			H	L	H	L	H	L	H	L	H	L	

Slave master telegram

STX	LGE	ADR	PKE		IND		PWE		ZSW		HIW		BCC
02h			H	L	H	L	H	L	H	L	H	L	

with

- STX - Start sign
- STW - Control word
- LGE - Telegram length
- ZSW - State word
- ADR - Address
- HSW - Main set value
- PKE - Parameter ID
- HIW - Main effective value
- IND - Index
- BCC - Block Check Character
- PWE - Parameter value

Broadcast with set bit 5 in ADR byte

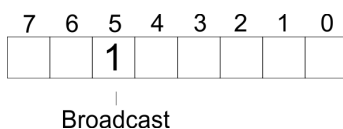

A request can be directed to a certain slave ore be send to all slaves as broadcast message. For the identification of a broadcast message you have to set bit 5 to 1 in the ADR byte. Here the slave addr. (bit 0 ... 4) is ignored. In opposite to a "normal" send command, the broadcast does not require a telegram evaluation via FC/SFC 218 SER_RCV. Only write commands may be sent as broadcast.

Modbus

- The Modbus protocol is a communication protocol that fixes a hierarchic structure with one master and several slaves.
- Physically, Modbus works with a serial half-duplex connection. There are no bus conflicts occurring, because the master can only communicate with one slave at a time.

- After a request from the master, this waits for a preset delay time for an answer of the slave. During the delay time, communication with other slaves is not possible.
- After a send command, the acknowledgement telegram must be read by a call of the FC/SFC 218 SER_RCV.
- The request telegrams send by the master and the respond telegrams of a slave have the following structure:

Telegram structure

Start sign	Slave address	Function Code	Data	Flow control	End sign
------------	---------------	---------------	------	--------------	----------

Broadcast with slave address = 0

- A request can be directed to a special slave or at all slaves as broadcast message.
- To mark a broadcast message, the slave address 0 is used.
- In opposite to a "normal" send command, the broadcast does not require a telegram evaluation via FC/SFC 218 SER_RCV.
- Only write commands may be sent as broadcast.

ASCII, RTU mode

Modbus offers 2 different transfer modes. The mode selection happens during runtime by using the FC/SFC 216 SER_CFG.

- ASCII mode: Every byte is transferred in the 2 sign ASCII code. The data are marked with a start and an end sign. This causes a transparent but slow transfer.
- RTU mode: Every byte is transferred as one character. This enables a higher data pass through as the ASCII mode. Instead of start and end sign, a time control is used.

Supported Modbus protocols

The following Modbus Protocols are supported by the RS485 interface:

- Modbus RTU Master
- Modbus ASCII Master

6.8 Modbus - Function codes

Naming convention

Modbus has some naming conventions:

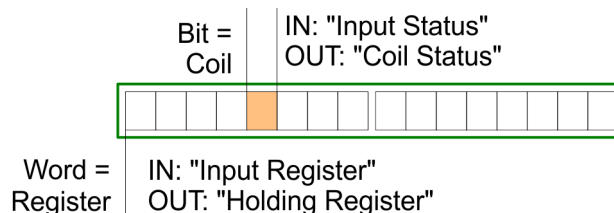

- Modbus differentiates between bit and word access; bits = "Coils" and words = "Register".
- Bit inputs are referred to as "Input-Status" and bit outputs as "Coil-Status".
- word inputs are referred to as "Input-Register" and word outputs as "Holding-Register".

Range definitions

Normally the access at Modbus happens by means of the ranges 0x, 1x, 3x and 4x.

0x and 1x gives you access to digital bit areas and 3x and 4x to analog word areas.

For the CPs from VIPA is not differentiating digital and analog data, the following assignment is valid:

0x - Bit area for master output data

Access via function code 01h, 05h, 0Fh

1x - Bit area for master input data

Access via function code 02h

3x - word area for master input data

Access via function code 04h

4x - word area for master output data

Access via function code 03h, 06h, 10h

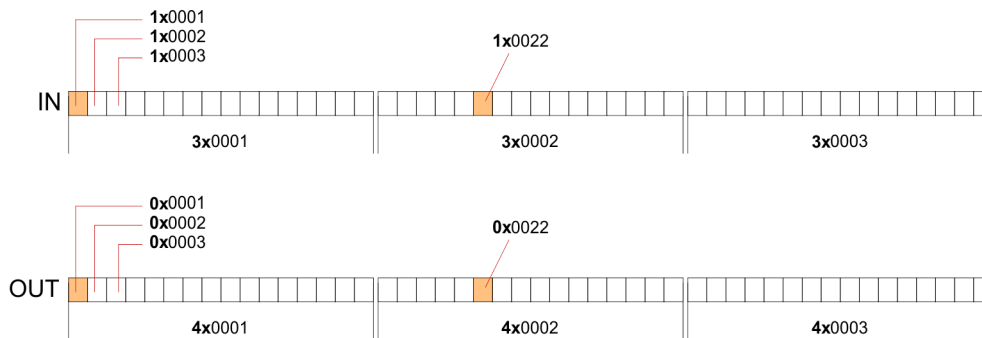

A description of the function codes follows below.

Overview

With the following Modbus function codes a Modbus master can access a Modbus slave: With the following Modbus function codes a Modbus master can access a Modbus slave. The description always takes place from the point of view of the master:

Code	Command	Description
01h	Read n bits	Read n bits of master output area 0x
02h	Read n bits	Read n bits of master input area 1x
03h	Read n words	Read n words of master output area 4x
04h	Read n words	Read n words master input area 3x
05h	Write 1 bit	Write 1 bit to master output area 0x
06h	Write 1 word	Write 1 word to master output area 4x
0Fh	Write n bits	Write n bits to master output area 0x
10h	Write n words	Write n words to master output area 4x

Point of View of "Input" and "Output" data

The description always takes place from the point of view of the master. Here data, which were sent from master to slave, up to their target are designated as "output" data (OUT) and contrary slave data received by the master were designated as "input" data (IN).

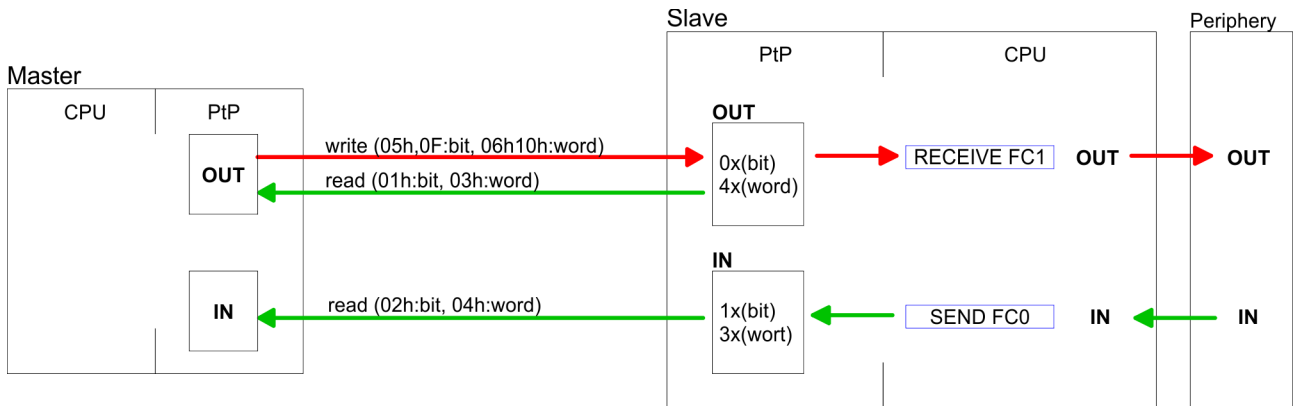

Respond of the slave

If the slave announces an error, the function code is send back with an "ORed" 80h.

Without an error, the function code is sent back.

Slave answer:	Function code OR 80h	→ Error
	Function code	→ OK

Byte sequence in a word

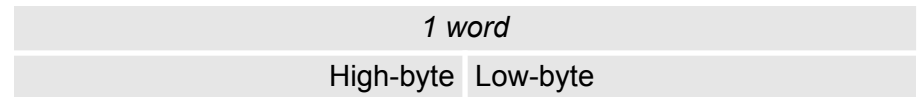

Check sum CRC, RTU, LRC

The shown check sums CRC at RTU and LRC at ASCII mode are automatically added to every telegram. They are not shown in the data block.

Read n bits 01h, 02h

Code 01h: Read n bits of master output area 0x
 Code 02h: Read n bits of master input area 1x

Command telegram

Slave address	Function code	Address 1. bit	Number of bits	Check sum CRC/LRC
1byte	1byte	1word	1word	1word

Respond telegram

Slave address	Function code	Number of read bytes	Data 1. byte	Data 2. byte	...	Check sum CRC/LRC
1byte	1byte	1byte	1byte	1byte		1word
			max. 250byte			

Read n words 03h, 04h 03h: Read n words of master output area 4x
 04h: Read n words master input area 3x

Command telegram

Slave address	Function code	Address 1. bit	Number of words	Check sum CRC/LRC
1byte	1byte	1word	1word	1word

Respond telegram

Slave address	Function code	Number of read bytes	Data 1. word	Data 2. word	...	Check sum CRC/LRC
1byte	1byte	1byte	1word	1word		1word
			max. 125words			

Write 1 bit 05h Code 05h: Write 1 bit to master output area 0x
 A status change is via "Status bit" with following values:
 "Status bit" = 0000h → Bit = 0
 "Status bit" = FF00h → Bit = 1

Command telegram

Slave address	Function code	Address bit	Status bit	Check sum CRC/LRC
1byte	1byte	1word	1word	1word

Respond telegram

Slave address	Function code	Address bit	Status bit	Check sum CRC/LRC
1byte	1byte	1word	1word	1word

Write 1 word 06h

Code 06h: Write 1 word to master output area 4x

Command telegram

Slave address	Function code	Address word	Value word	Check sum CRC/LRC
1byte	1byte	1word	1word	1word

Respond telegram

Slave address	Function code	Address word	Value word	Check sum CRC/LRC
1byte	1byte	1word	1word	1word

Write n bits 0Fh

Code 0Fh: Write n bits to master output area 0x

Please regard that the number of bits has additionally to be set in byte.

Command telegram

Slave address	Function code	Address 1. bit	Number of bits	Number of bytes	Data 1. byte	Data 2. byte	...	Check sum CRC/LRC
1byte	1byte	1word	1word	1byte	1byte	1byte	1byte	1word
					max. 250byte			

Respond telegram

Slave address	Function code	Address 1. bit	Number of bits	Check sum CRC/LRC
1byte	1byte	1word	1word	1word

Write n words 10h

Code 10h: Write n words to master output area 4x

Command telegram

Slave address	Function code	Address 1. word	Number of words	Number of bytes	Data 1. word	Data 2. word	...	Check sum CRC/LRC
1byte	1byte	1word	1word	1byte	1word	1word	1word	1word
					max. 125words			

Respond telegram

Slave address	Function code	Address 1. word	Number of words	Check sum CRC/LRC
1byte	1byte	1word	1word	1word

7 Option: PROFIBUS communication

7.1 Overview



To switch the interface X3 MPI(PtP) to PROFIBUS functionality you have to activate the according bus functionality by means of a VSC storage media from VIPA. By plugging the VSC storage card and then an overall reset the according functionality is activated. ↪ 'Deployment storage media - VSD, VSC' on page 85

PROFIBUS DP

- PROFIBUS is an international standard applicable to an open and serial field bus for building, manufacturing and process automation that can be used to create a low (sensor-/actuator level) or medium (process level) performance network of programmable logic controllers.
- PROFIBUS comprises an assortment of compatible versions. The following details refer to PROFIBUS DP.
- PROFIBUS DP is a special protocol intended mainly for automation tasks in a manufacturing environment. DP is very fast, offers Plug'n'Play facilities and provides a cost-effective alternative to parallel cabling between PLC and remote I/O. PROFIBUS DP was designed for high-speed data communication on the sensor-actuator level.
- The data transfer referred to as "Data Exchange" is cyclical. During one bus cycle, the master reads input values from the slaves and writes output information to the slaves.

DP slave operation

For the deployment in a super-ordinated master system you first have to project your slave system as Siemens CPU in slave operation mode with configured in-/output areas. Afterwards you configure your master system. Couple your slave system to your master system by dragging the CPU 31x from the hardware catalog at *Configured stations* onto the master system, choose your slave system and connect it.

Operating mode DP slave: Test, commissioning, routing (active/passive)

There is the possibility to enable the option '*Test, commissioning, routing*' in the hardware configuration by means of the properties dialog of the PROFIBUS via the register '*Operating mode*' at '*DP slave*'. The activation affects as follows:

- The PROFIBUS interface gets an "active" PROFIBUS node, this means it is involved in the token rotation.
- Via this interface you have PG/OP functions (programming, status request, control, test).
- The PROFIBUS interface serves as a gateway (S7 routing).
- The bus rotation time can exceed.

When disabled, the PROFIBUS interface operates as a server for communication services with the following characteristics:

- The PROFIBUS interface gets an "passive" PROFIBUS node, this means it is not involved in the token rotation.
- Via this interface you have PG/OP functions (programming, status request, control, test).
- The speed of the PG/OP functions is limited.

- Bus rotation time is not influenced.
- S7 routing is not possible.

7.2 Fast introduction

Overview

The PROFIBUS DP slave is to be configured in the hardware configurator from Siemens. Here the configuration happens by the sub module X1 (MPI/DP) of the Siemens CPU.



To switch the interface X3 MPI(PtP) to PROFIBUS functionality you have to activate the according bus functionality by means of a VSC storage media from VIPA. By plugging the VSC storage card and then an overall reset the according functionality is activated. ↪ 'Deployment storage media - VSD, VSC' on page 85

Steps of configuration

The configuration of the PROFIBUS DP slave should be done with the following approach:

- **Activating bus functionality by means of a VSC**
- **Hardware configuration - CPU**
- **Use as DP slave**
 - With activating the bus functionality 'PROFIBUS DP-slave' by means of a VSC, the bus functionality 'PROFIBUS DP-slave' is unlocked.
- **Transfer of the entire project to the CPU**



With the Siemens SIMATIC Manager, the CPU 013-CCF0R00 from VIPA is to be configured as

CPU 314C-2 PN/DP (314-6EH04-0AB0 V3.3)!

The integrated PROFIBUS DP slave (X3) is to be configured and connected via the sub module X1 (MPI/DP).

7.3 Enable bus functionality via VSC

Enabling

↪ 'Deployment storage media - VSD, VSC' on page 85

7.4 Deployment as PROFIBUS DP slave

Fast introduction

In the following the deployment of the PROFIBUS section as "intelligent" DP slave on master system is described, which exclusively may be configured in the Siemens SIMATIC Manager. The following steps are required:

1. ➤ Configure a station with a CPU with operating mode DP slave.
2. ➤ Connect to PROFIBUS and configure the in-/output area for the slave section.
3. ➤ Save and compile your project.
4. ➤ Configure another station with another CPU with operating mode DP master.
5. ➤ Connect to PROFIBUS and configure the in-/output ranges for the master section.
6. ➤ Save, compile and transfer your project to your CPU.

Project engineering of the slave section

1. ➤ Start the Siemens SIMATIC Manager and configure a CPU as described at "Hardware configuration - CPU".
2. ➤ Designate the station as "...DP slave".
3. ➤ Add your modules according to the real hardware assembly.
4. ➤ Open the properties dialog of the DP interface of the CPU by means of a double-click at 'MPI/DP'.
5. ➤ Set Interface type to "PROFIBUS".
6. ➤ Connect to PROFIBUS and preset an address (e.g. 3) and confirm with [OK].
7. ➤ Switch at Operating mode to "DP slave" .
8. ➤ Via Configuration you define the in-/output address area of the slave CPU, which are to be assigned to the DP slave.
9. ➤ Save, compile and transfer your project to your CPU.

Slave section

Standard bus	
Slot	Module
1	
2	CPU ...
X1	MPI/DP
X...	...
3	
4	...
5	Modules
6	...

Object properties

Operating mode: DP slave
 Connect: PROFIBUS
 PROFIBUS address: > 1

Configuration:
 Input area
 Output area

Project engineering of the master section

1. ➤ Insert another station and configure a CPU.
2. ➤ Designate the station as "...DP master".
3. ➤ Add your modules according to the real hardware assembly.
4. ➤ Open the properties dialog of the DP interface of the CPU by means of a double-click at 'MPI/DP'.

5. ➤ Set Interface: type to "PROFIBUS".
6. ➤ Connect to PROFIBUS and preset an address (e.g. 2) and confirm with [OK].
7. ➤ Switch at Operating mode to "DP master" and confirm the dialog with [OK].
8. ➤ Connect your slave system to this master system by dragging the "CPU 31x" from the hardware catalog at *Configured stations* onto the master system and select your slave system to be coupled.
9. ➤ Open the *Configuration at Object properties* of your slave system.
10. ➤ Via double click to the according configuration line you assign the according input address area on the master CPU to the slave output data and the output address area to the slave input data.
11. ➤ Save, compile and transfer your project to your CPU.

Master section

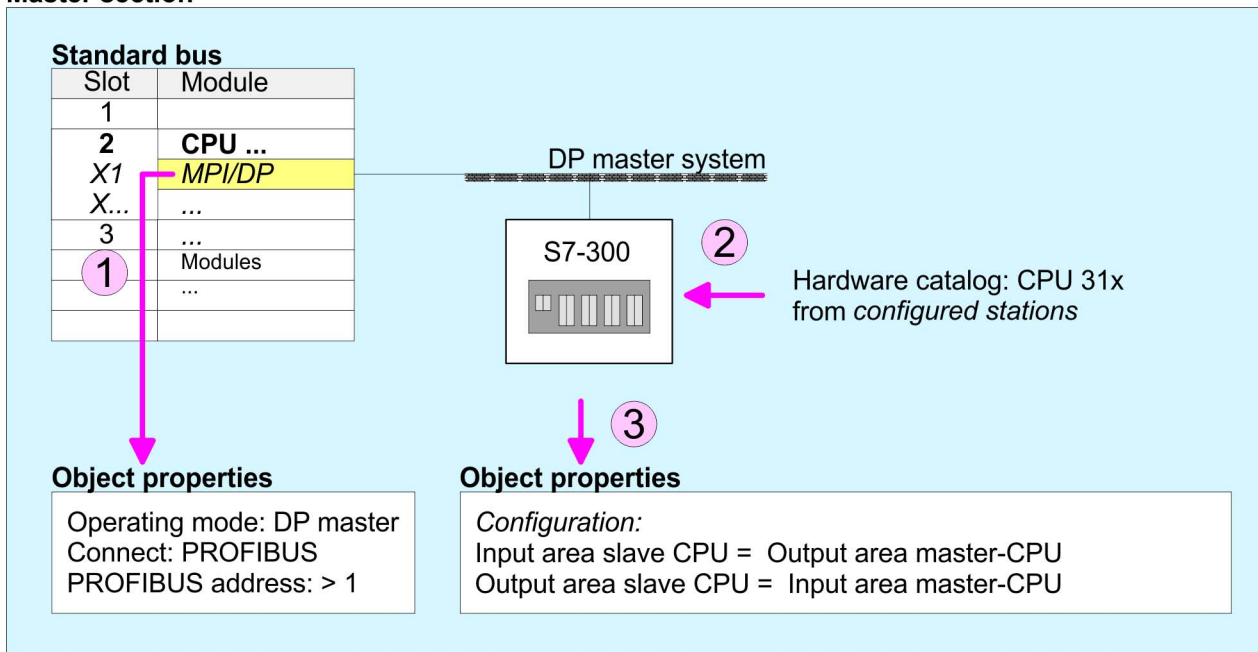

7.5 PROFIBUS installation guidelines

PROFIBUS in general

- A PROFIBUS DP network may only be built up in linear structure.
- PROFIBUS DP consists of minimum one segment with at least one master and one slave.
- A master has always been deployed together with a CPU.
- PROFIBUS supports max. 126 participants.
- Per segment a max. of 32 participants is permitted.
- The max. segment length depends on the transfer rate:
9.6 ... 187.5bit/s → 1000m
500kbit/s → 400m
1.5Mbit/s → 200m
3 ... 12Mbit/s → 100m
- Max. 10 segments may be built up. The segments are connected via repeaters. Every repeater counts for one participant.
- The bus respectively a segment is to be terminated at both ends.
- All participants are communicating with the same transfer rate. The slaves adjust themselves automatically on the transfer rate.

Transfer medium

- As transfer medium PROFIBUS uses an isolated twisted-pair cable based upon the RS485 interface.
- The RS485 interface is working with voltage differences. Though it is less irritable from influences than a voltage or a current interface. You are able to configure the network as well linear as in a tree structure.
- Max. 32 participants per segment are permitted. Within a segment the members are linear connected. The segments are connected via repeaters. The maximum segment length depends on the transfer rate.
- PROFIBUS DP uses a transfer rate between 9.6kbit/s and 12Mbit/s, the slaves are following automatically. All participants are communicating with the same transfer rate.
- The bus structure under RS485 allows an easy connection res. disconnection of stations as well as starting the system step by step. Later expansions don't have any influence on stations that are already integrated. The system realizes automatically if one partner had a fail down or is new in the network.

Bus connection

The following picture illustrates the terminating resistors of the respective start and end station.

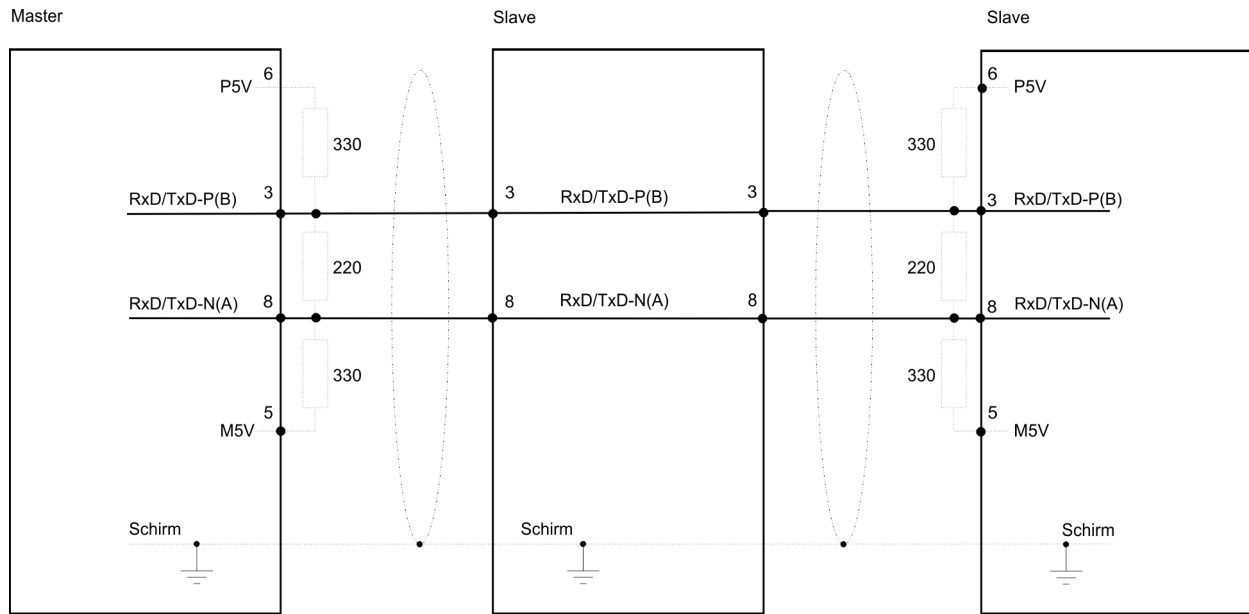

The PROFIBUS line has to be terminated with its ripple resistor. Please make sure to terminate the last participants on the bus at both ends by activating the terminating resistor.

EasyConn bus connector



In PROFIBUS all participants are wired parallel. For that purpose, the bus cable must be feed-through. Via the order number 972-0DP10 you may order the bus connector "EasyConn". This is a bus connector with switchable terminating resistor and integrated bus diagnostic.

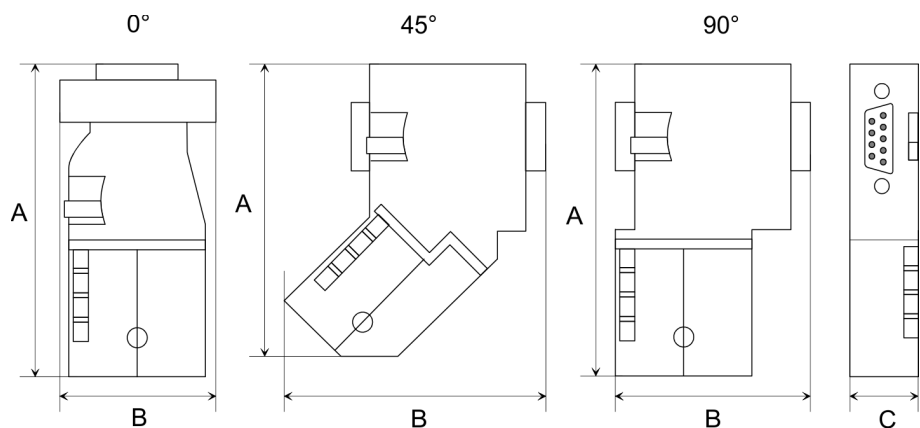

Dimensions in mm	0°	45°	90°
A	64	61	66
B	34	53	40
C	15.8	15.8	15.8



To connect this EasyConn plug, please use the standard PROFIBUS cable type A (EN50170). Starting with release 5 you also can use highly flexible bus cable:

Lapp Kabel order no: 2170222, 2170822, 2170322.

With the order no. 905-6AA00 VIPA offers the "EasyStrip" de-isolating tool that makes the connection of the EasyConn much easier.

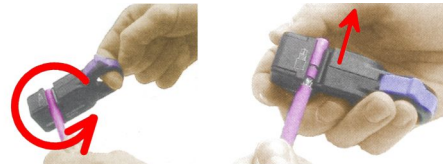
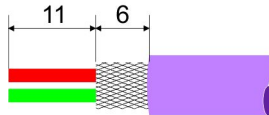

Dimensions in mm

Termination with "EasyConn"

The "EasyConn" bus connector is provided with a switch that is used to activate a terminating resistor.

Wiring

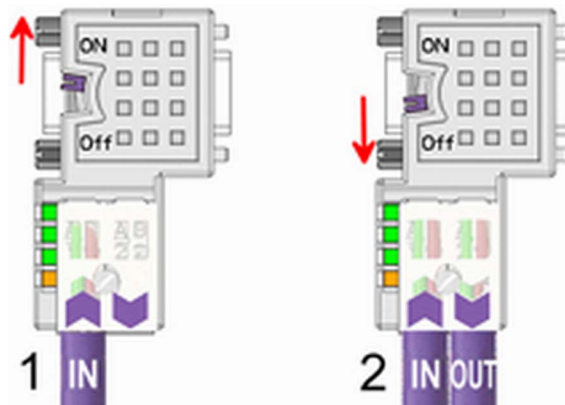

- [1] 1./last bus participant
- [2] further participants



CAUTION!

The terminating resistor is only effective, if the connector is installed at a bus participant and the bus participant is connected to a power supply.

The tightening torque of the screws to fix the connector to a device must not exceed 0.02Nm!



A complete description of installation and deployment of the terminating resistors is delivered with the connector.

Assembly

1. ▶ Loosen the screw.
2. ▶ Lift contact-cover.
3. ▶ Insert both wires into the ducts provided (watch for the correct line colour as below!)
4. ▶ Please take care not to cause a short circuit between screen and data lines!
5. ▶ Close the contact cover.
6. ▶ Tighten screw (max. tightening torque 0.08Nm).



The green line must be connected to A, the red line to B!

7.6 Commissioning and Start-up behavior**Start-up on delivery**

In delivery the CPU is overall reset. The PROFIBUS part is deactivated and its LEDs are off after Power ON.

Online with bus parameter without slave project

The DP master can be served with bus parameters by means of a hardware configuration. As soon as these are transferred the DP master goes online with his bus parameter. This is shown by the RUN LED. Now the DP master can be contacted via PROFIBUS by means of his PROFIBUS address. In this state the CPU can be accessed via PROFIBUS to get configuration and DP slave project.

Slave configuration

If the master has received valid configuration data, he switches to *Data Exchange* with the DP slaves. This is indicated by the DE-LED.

CPU state controls DP master

After PowerON respectively a receipt of a new hardware configuration the configuration data and bus parameter were transferred to the DP master. Dependent on the CPU state the following behavior is shown by the DP master:

Master behavior at CPU STOP

- The global control command "Clear" is sent to the slaves by the master. Here the DE-LED is blinking.
- DP slaves with fail safe mode were provided with output telegram length "0".
- DP slaves without fail safe mode were provided with the whole output telegram but with output data = 0.
- The input data of the DP slaves were further cyclically transferred to the input area of the CPU.

Master behavior at CPU RUN

- The global control command "Operate" is sent to the slaves by the master. Here the DE-LED is on.
- Every connected DP slave is cyclically attended with an output telegram containing recent output data.
- The input data of the DP slaves were cyclically transferred to the input area of the CPU.

8 Configuration with TIA Portal

8.1 TIA Portal - Work environment

8.1.1 General

General

In this chapter the project engineering of the VIPA CPU in the Siemens TIA Portal is shown. Here only the basic usage of the Siemens TIA Portal together with a VIPA CPU is shown. Please note that software changes can not always be considered and it may thus be deviations to the description. TIA means **T**otally **I**ntegrated **A**utomation from Siemens. Here your VIPA PLCs may be configured and linked. For diagnostics online tools are available.



Information about the Siemens TIA Portal can be found in the online help respectively in the according online documentation.

Starting the TIA Portal

To start the Siemens TIA Portal with Windows select 'Start → Programs → Siemens Automation → TIA ...'

Then the TIA Portal opens with the last settings used.

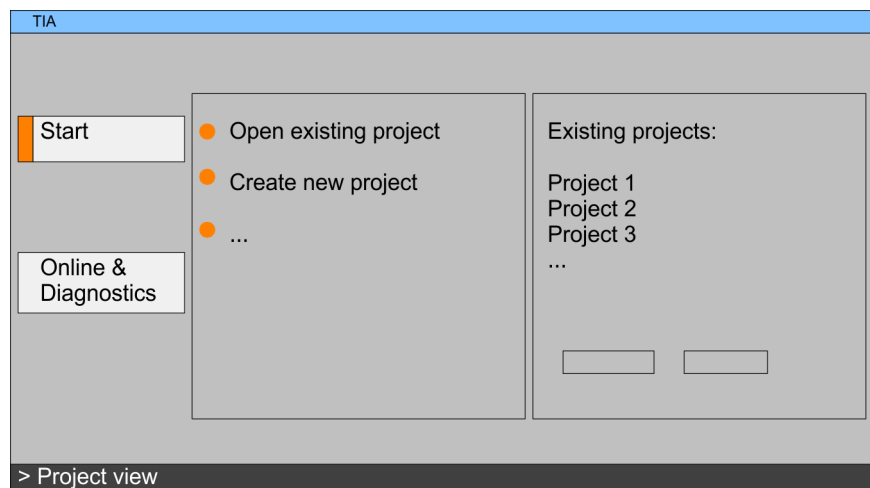

Exiting the TIA Portal

With the menu 'Project → Exit' in the 'Project view' you may exit the TIA Portal. Here there is the possibility to save changes of your project before.

8.1.2 Work environment of the TIA Portal

Basically, the TIA Portal has the following 2 views. With the button on the left below you can switch between these views:

Portal view

The 'Portal view' provides a "task oriented" view of the tools for processing your project. Here you have direct access to the tools for a task. If necessary, a change to the Project view takes place automatically for the selected task.

Project view

The 'Project view' is a "structured" view to all constituent parts of your project.

Areas of the Project view

The Project view is divided into the following areas:

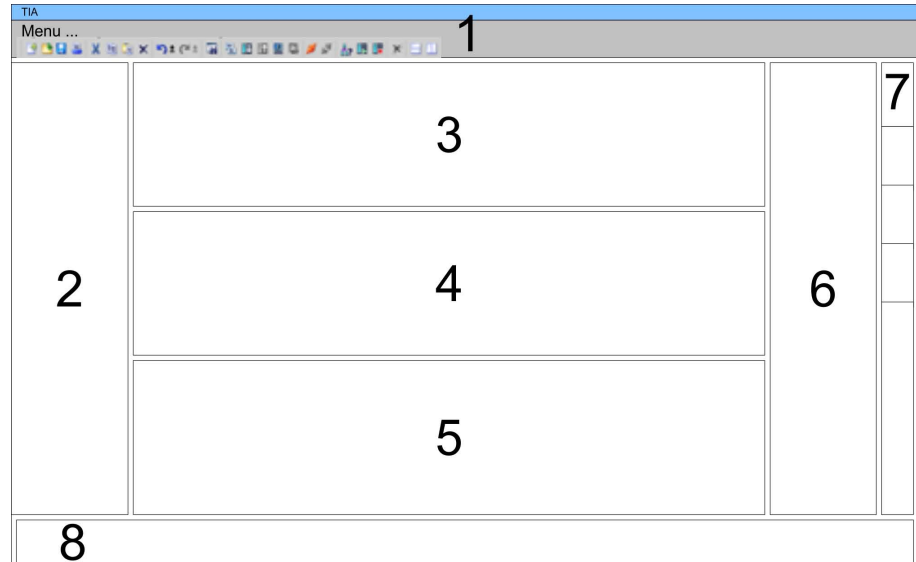

- 1 Menu bar with toolbars
- 2 Project tree with Details view
- 3 Project area
- 4 Device overview of the project respectively area for block programming
- 5 Properties dialog of a device (parameter) respectively information area
- 6 Hardware catalog and tools
- 7 "Task-Cards" to select hardware catalog, tasks and libraries
- 8 Jump to Portal or Project view

8.2 TIA Portal - Hardware configuration - CPU

Overview

The hardware configuration of the CPU and its plugged modules happens in the Siemens TIA Portal by means of a virtual PROFINET IO device. For the PROFINET interface is standardized software sided, the functionality is guaranteed by including a GSDML file into the Siemens TIA Portal.

The hardware configuration of the CPU is divided into the following parts:

- Installation GSDML SLIO CPU PROFINET
- Configuration Siemens CPU
- Connection SLIO CPU as PROFINET IO device

Installation GSDML SLIO CPU for PROFINET

The installation of the PROFINET IO devices 'VIPA SLIO CPU' happens in the hardware catalog with the following approach:

1. Go to the service area of www.vipa.com.
2. Load from the download area at 'PROFINET files' the file System SLIO_Vxxx.zip.
3. Extract the file into your working directory.
4. Start the Siemens TIA Portal.

5. ➤ Close all the projects.
6. ➤ Switch to the *Project view*.
7. ➤ Select '*Options → Install general station description file (GSD)*'.
8. ➤ Navigate to your working directory and install the according GSDML file.
 - ⇒ After the installation the hardware catalog is refreshed and the Siemens TIA Portal is finished.

After restarting the Siemens TIA Portal the according PROFINET IO device can be found at *Other field devices > PROFINET > IO > VIPA GmbH > VIPA SLIO System*.



Thus, the VIPA components can be displayed, you have to deactivate the "Filter" of the hardware catalog.

Configuration Siemens CPU

With the Siemens TIA Portal, the CPU from VIPA is to be configured as CPU 314C-2 PN/DP (6ES7 314-6EH04-0AB0 V3.3) from Siemens.

1. ➤ Start the Siemens TIA Portal.
2. ➤ Create a new project in the *Portal view* with '*Create new project*'.
3. ➤ Switch to the *Project view*.
4. ➤ Click in the *Project tree* at '*Add new device*'.
5. ➤ Select the following CPU in the input dialog:
 SIMATIC S7-300 > CPU 314C-2 PN/DP > 6ES7 314-6EH04-0AB0 V3.3
 ⇒ The CPU is inserted with a profile rail.

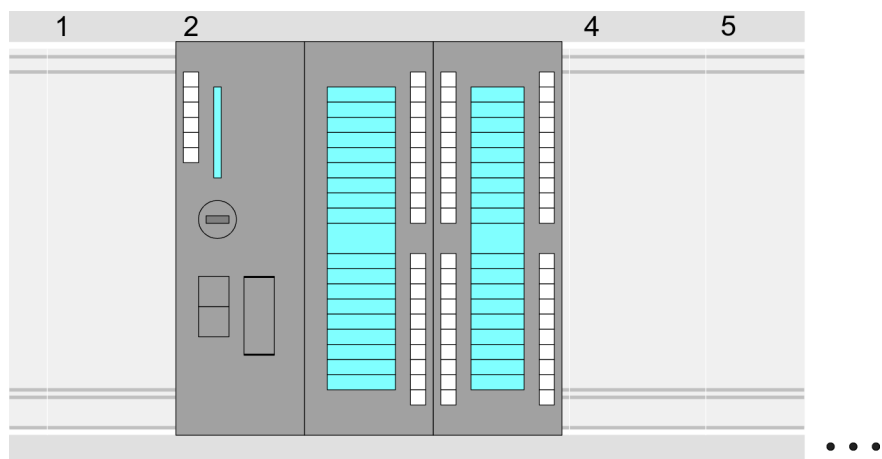

Device overview:

Module	...	Slot	...	Type	...
PLC ...		2		CPU 314C-2PN/DP	

MPI inter- face...	2 X1	MPI/DP interface
PROFINET interface	2 X2	PROFINET interface
DI24/DO16	2 5	DI24/DO16
AI5/AO2...	2 6	AI5/AO2
Counter...	2 7	Counter
...		

Setting standard CPU parameters

Since the CPU from VIPA is configured as Siemens CPU, so the setting of the non- VIPA specific parameters takes place via the Siemens CPU. For parametrization click in the *Project area* respectively in the *Device overview* at the CPU part. Then the parameters of the CPU part are shown in the *Properties dialog*. Here you can make your parameter settings. ↪ *'Setting standard CPU parameters' on page 66*

Connection SLIO CPU as PROFINET IO device

1. ▶ Switch in the *Project area* to *'Network view'*.
2. ▶ After installing the GSDML the IO device for the SLIO CPU may be found in the hardware catalog at *Other field devices > PROFINET > IO > VIPA GmbH > VIPA SLIO System*. Connect the slave system to the CPU by dragging&dropping it from the hardware catalog to the *Network view* and connecting it via PROFINET to the CPU.
3. ▶ Click in the *Network view* at the PROFINET part of the Siemens CPU and enter at valid IP address data in *'Properties'* at *'Ethernet address'* in the area *'IP protocol'*.
4. ▶ Enter at *'PROFINET'* a *'PROFINET device name'*. The device name must be unique at the Ethernet subnet.

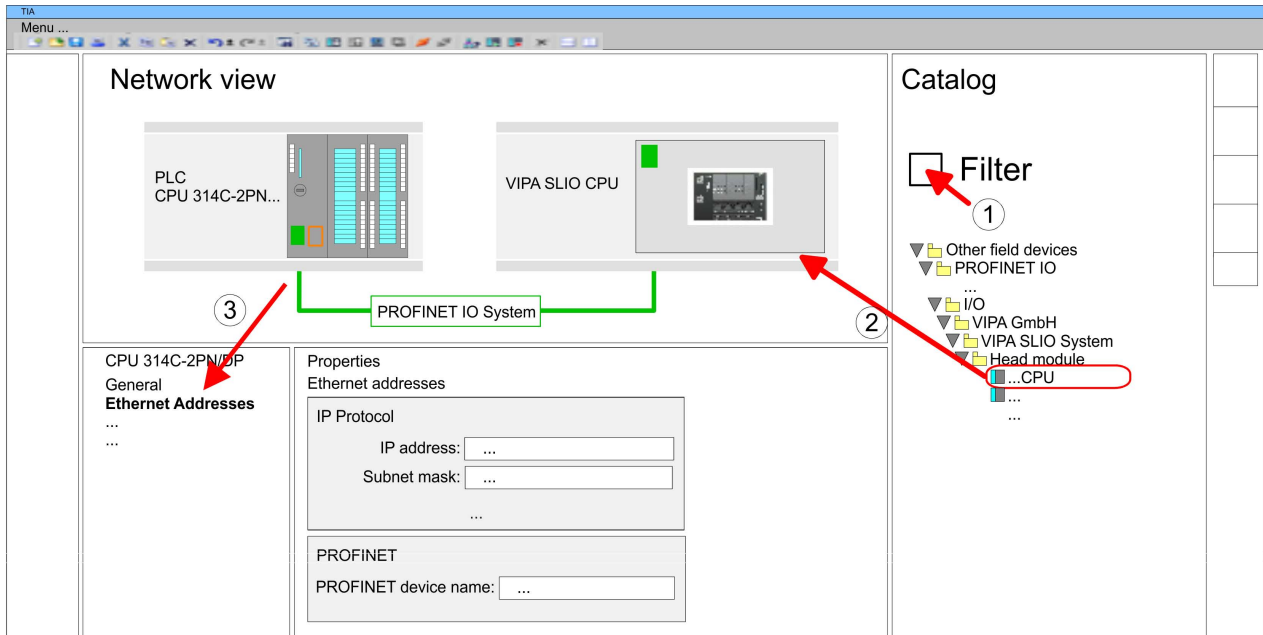

5. ➤ Select in the *Network view* the IO device 'VIPA SLIO CPU...' and switch to the *Device overview*.
 - ⇒ In the *Device overview* of the PROFINET IO device 'VIPA SLIO CPU' the CPU is already placed at slot 0. From slot 1 you can place your System SLIO modules.

Setting VIPA specific CPU parameters

For parametrization click at the CPU at slot 0 in the *Device overview* of the PROFINET IO device 'VIPA SLIO CPU'. Then the parameters of the CPU part are shown in the *Properties dialog*. Here you can make your parameter settings. ↪ 'Setting VIPA specific CPU parameters' on page 70

8.3 TIA Portal - Hardware configuration - Ethernet PG/OP channel

Overview

The CPU has an integrated Ethernet PG/OP channel. This channel allows you to program and remote control your CPU.

- The Ethernet PG/OP channel (X1/X2) is designed as switch. This enables PG/OP communication via the connections X1 and X2.
- The Ethernet PG/OP channel also gives you access to the internal web page that contains information about firmware version, connected I/O devices, current cycle times etc.
- At the first commissioning respectively after a factory reset the Ethernet PG/OP channel has no IP address.
- For online access to the CPU via the Ethernet PG/OP channel, valid IP address parameters have to be assigned to this. This is called "initialization".
- This can be done with the Siemens TIA Portal.

Assembly and commissioning

1. ➤ Install your System SLIO with your CPU.
2. ➤ Wire the system by connecting cables for voltage supply and signals.

3. ➤ Connect the one of the Ethernet jack (X1, X2) of the Ethernet PG/OP channel to Ethernet, to which your programming device (PC) is connected.
4. ➤ Switch on the power supply.
 - ⇒ After a short boot time the CPU is ready for communication. It possibly has no IP address data and requires an initialization.

"Initialization" via Online functions

The initialization via the Online functions takes place with the following proceeding:

- Determine the current Ethernet (MAC) address of your Ethernet PG/OP channel. This can be found at the front of the CPU labelled as "MAC PG/OP: ...".

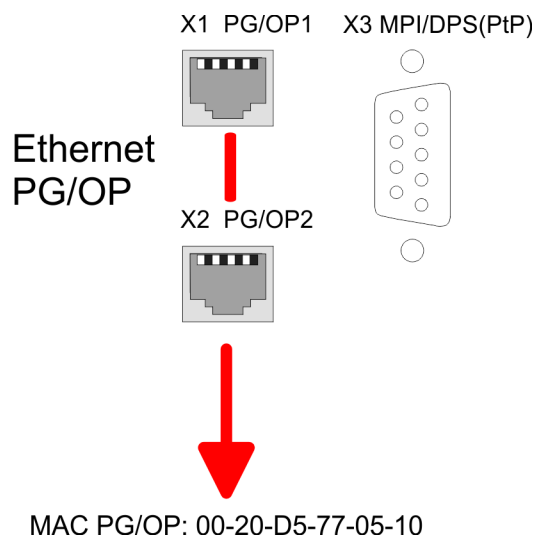

Assign IP address parameters

You get valid IP address parameters from your system administrator. The assignment of the IP address data happens online in the Siemens TIA Portal with the following proceeding:

1. ➤ Start the Siemens TIA Portal.
2. ➤ Switch to the 'Project view'.
3. ➤ Click in the 'Project tree' at 'Online access' and choose here by a doubleclick your network card, which is connected to the Ethernet PG/OP channel.
4. ➤ To get the stations and their MAC address, use the 'Accessible device'. This can be found at the front of the CPU labelled as "MAC PG/OP: ...".
5. ➤ Choose from the list the module with the known MAC address (Onboard PG/OP [MAC address]) and open with "Online & Diagnostics" the diagnostics dialog in the Project area.
6. ➤ Navigate to *Functions > Assign IP address*. Type in the IP configuration like IP address, subnet mask and gateway.

7. ➤ Confirm with [Assign IP configuration].
 - ⇒ Directly after the assignment the Ethernet PG/OP channel is online reachable using the set IP address data. The value remains as long as it is reassigned, it is overwritten by a hardware configuration or an factory reset is executed.

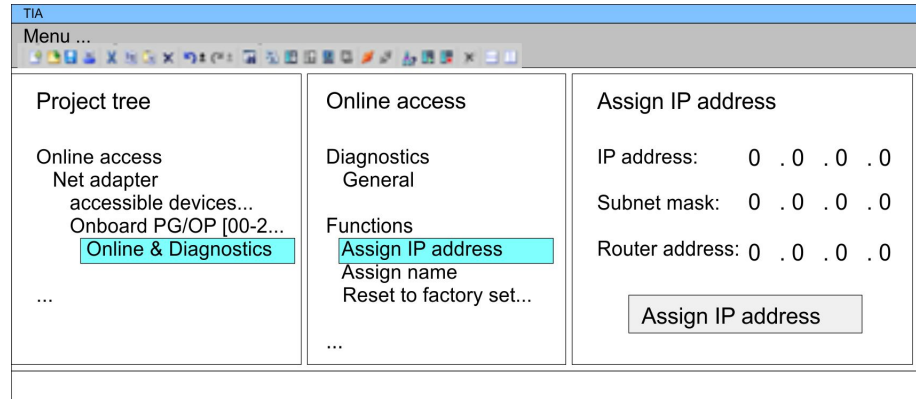

i Due to the system you may get a message that the IP address could not be assigned. This message can be ignored.

Take IP address parameters in project

1. ➤ Open your project.
2. ➤ If not already done, configure in the 'Device configuration' a Siemens CPU 314C-2 PN/DP (314-6EH04-0AB0 V3.3).
3. ➤ As Ethernet PG/OP channel place at slot 4 the Siemens CP 343-1 (6GK7 343-1EX21 0XE0 V.1.2).
4. ➤ Open the "Property" dialog by clicking on the CP 343-1EX21 and enter for the CP at "Properties" at "Ethernet address" the IP address data, which you have assigned before.
5. ➤ Transfer your project.

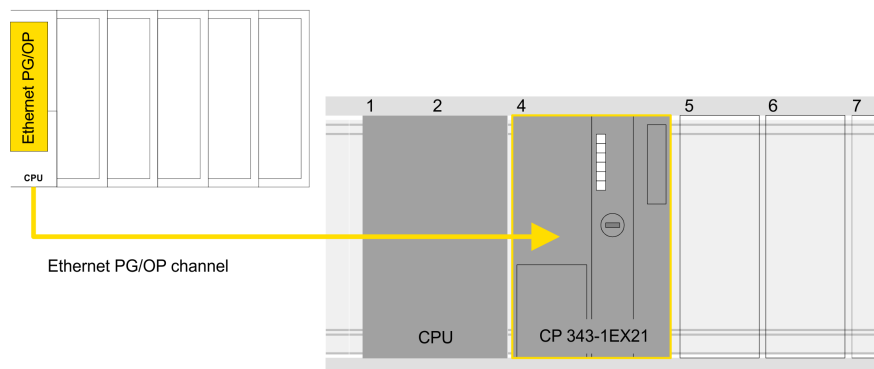

Device overview:

Module	...	Slot	...	Type	...
PLC ...		2		CPU 315-2 PN/DP	

MPI/DP interface	2 X1	MPI/DP interface
PROFINET interface	2 X2	PROFINET interface
...
CP 343-1	4	CP 343-1
...

8.4 TIA Portal - Include VIPA library

Overview

- The VIPA specific blocks may be found at www.vipa.com as downloadable library at the "service" area with *Downloads > VIPA LIB*.
- The library is available as packed zip-file Fx000020_V... .
- If you want to use VIPA specific blocks, you have to import the library into your project.
Execute the following steps:
 - Extract Fx000020_V... .zip
 - Open library and transfer blocks into the project

**Unzip
FX000020_V... .zip**

Start your un-zip application with a double click on the file FX000020_V... .zip and copy all the files and folders in a work directory for the Siemens TIA Portal.

Open library and transfer blocks to project

1. ▶ Start the Siemens TIA Portal with your project.
2. ▶ Select the *Project view*.
3. ▶ Choose "Libraries" from the Task cards on the right side.
4. ▶ Click at "Global libraries".
5. ▶ Click at "Open global library".
6. ▶ Navigate to your directory and load the file VIPA_TIA.al11.

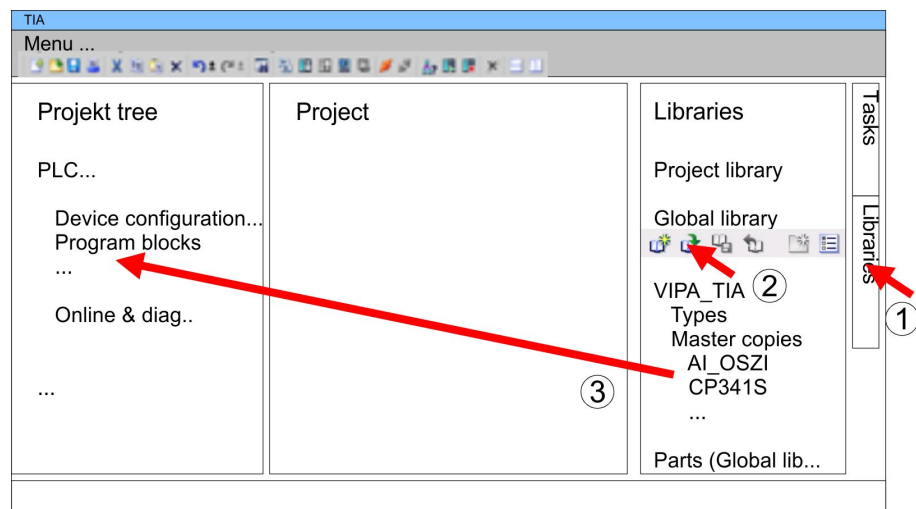

7. ▶ Copy the necessary blocks from the library into the "Program blocks" of the Project tree of your project. Now you have access to the VIPA specific blocks via your user application.

8.5 TIA Portal - Project transfer

Overview

There are the following possibilities for project transfer into the CPU:

- Transfer via MPI
- Transfer via Ethernet
- Transfer via memory card

Transfer via MPI

Currently the VIPA programming cables for transfer via MPI are not supported. This is only possible with the programming cable from Siemens.

1. ► Establish a connection to the CPU via MPI with an appropriate programming cable. Information may be found in the corresponding documentation of the programming cable.
2. ► Switch-ON the power supply of your CPU and start the Siemens TIA Portal with your project.
3. ► Select in the *Project tree* your CPU and choose '*Context menu* → *Download to device* → *Hardware configuration*' to transfer the hardware configuration.
4. ► To transfer the PLC program choose '*Context menu* → *Download to device* → *Software*'. Due to the system you have to transfer hardware configuration and PLC program separately.

Transfer via Ethernet

For transfer via Ethernet the CPU has the following interface:

- X1/X2: Ethernet PG/OP channel via an integrated 2-port switch

Initialization

So that you may the according Ethernet interface, you have to assign IP address parameters by means of the "initialization". ↪ '*TIA Portal - Hardware configuration - Ethernet PG/OP channel*' on page 235

Please consider to use the same IP address data in your project for the CP 343-1.

Transfer

1. ► For the transfer, connect, if not already done, the appropriate Ethernet jack to your Ethernet.
 2. ► Open your project with the Siemens TIA Portal.
 3. ► Click in the *Project tree* at *Online access* and choose here by a double-click your network card, which is connected to the Ethernet PG/OP interface.
 4. ► Select in the *Project tree* your CPU and click at [Go online].
 5. ► Set the access path by selecting "PN/IE" as type of interface, your network card and the according subnet. Then a net scan is established and the corresponding station is listed.
 6. ► Establish with [Connect] a connection.
 7. ► Click to '*Online* → *Download to device*'.
- ⇒ The according block is compiled and by a request transferred to the target device. Provided that no new hardware configuration is transferred to the CPU, the entered Ethernet connection is permanently stored in the project as transfer channel.

Transfer via memory card

The memory card serves as external storage medium. There may be stored several projects and sub-directories on a memory card. Please regard that your current project is stored in the root directory and has one of the following file names:

- S7PROG.WLD
- AUTOLOAD.WLD

1. ▶ Create in the Siemens TIA Portal a wld file with 'Project → Memory card file → New'.

⇒ The wld file is shown in the *Project tree* at "SIMATIC Card Reader" as "Memory card file".

2. ▶ Copy the blocks from the *Program blocks* to the wld file. Here the hardware configuration data are automatically copied to the wld file as "System data".

Transfer memory card → CPU

The transfer of the application program from the memory card into the CPU takes place depending on the file name after an overall reset or PowerON.

- *S7PROG.WLD* is read from the memory card after overall reset.
- *AUTOLOAD.WLD* is read from the memory card after PowerON.

The blinking of the SD LED of the CPU marks the active transfer. Please regard that your user memory serves for enough space for your user program, otherwise your user program is not completely loaded and the SF LED gets on.

Transfer CPU → Memory card

When a memory card has been installed, the write command stores the content of the RAM as *S7PROG.WLD* on the memory card. The write command can be found in the Siemens TIA Portal in the Task card "Online tools" in the command area at "Memory" as button [Copy RAM to ROM]. The SD LED blinks during the write access. When the LED expires, the write process is finished. If this project is to be loaded automatically from the memory card with PowerON, you have to rename this to on the memory card to *AUTOLOAD.WLD*.



Please note that in the Siemens TIA Portal with some CPU types the [Copy RAM to ROM] button is not available.

Checking the transfer operation

After accessing the memory card you can find a diagnostics entry in the CPU. To monitor the diagnostics entries, you select *Online & Diagnostics* in the Siemens TIA Portal. Here you can access the "Diagnostics buffer". ↪ '*Diagnostic entries*' on page 92